

# *Turfgrass Pest Management*

**Training for Commercial  
Pesticide Applicators  
Category 3A**

Developed by Greg Patchan, Julie Stachecki, and Kay Sicheneder



# Principles of Pest Management

## Chapter 1



**A pesticide applicator doesn't just apply pesticides. Social and legal responsibilities accompany the use of toxic materials.**

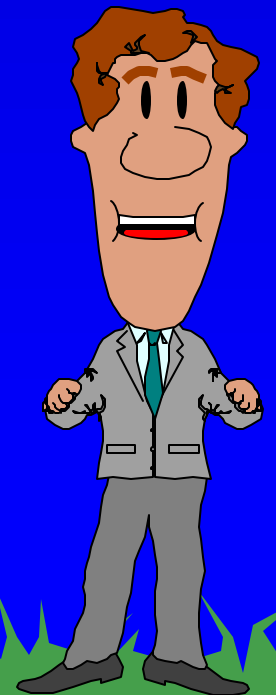

**Pesticide application must protect plant material from pest injury without endangering nontarget organisms.**

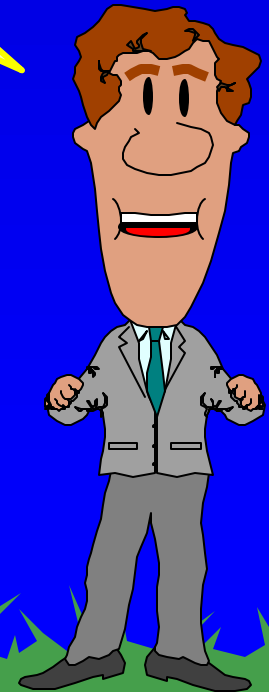
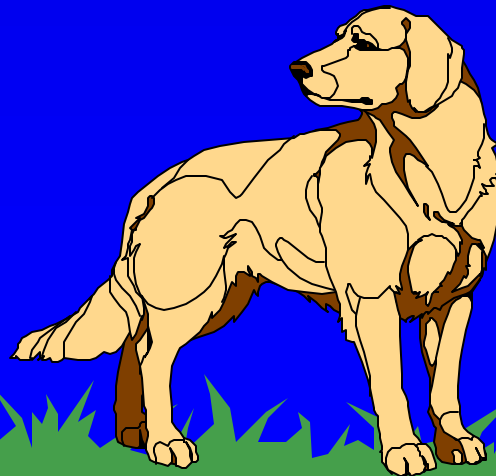
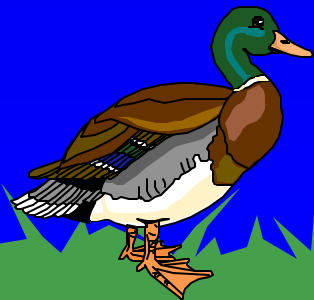

# Integrated Pest Management

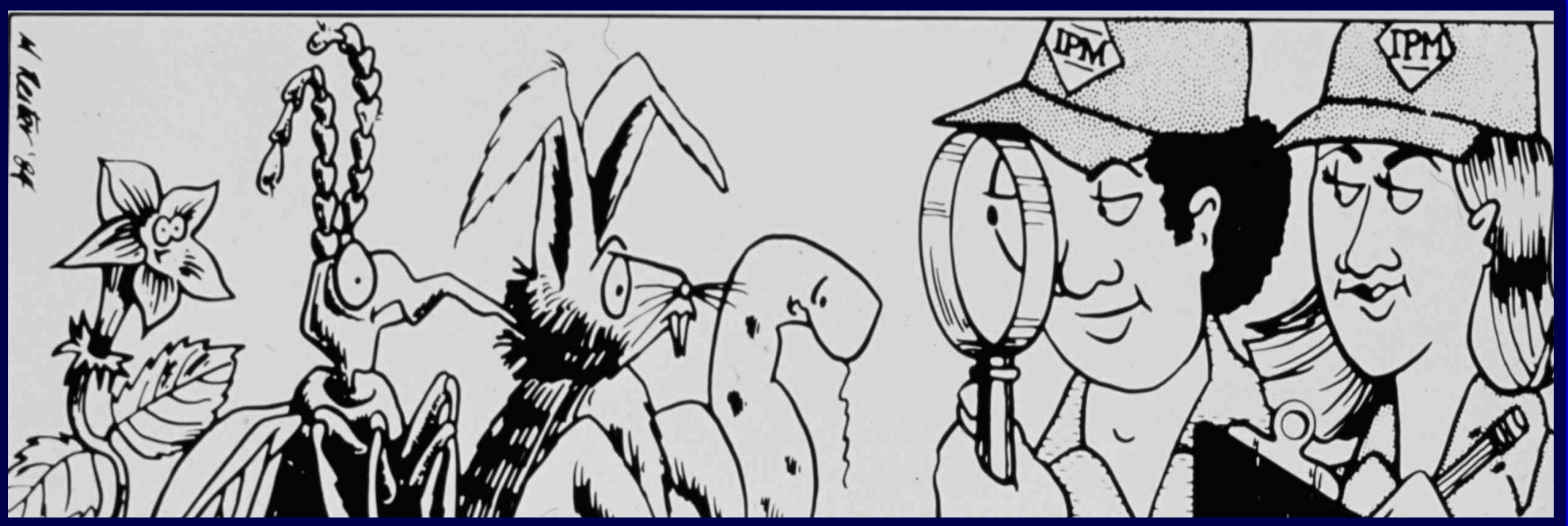

# *IPM*

- Use of all available strategies to manage pests.
- Achieve acceptable yield and quality.
- Least environmental disruption.

# *IPM*

## *Pest Control Strategies*

- Resistant varieties
- Cultural practices
- Natural enemies
- Mechanical controls
- Pesticides
- **IPM is NOT anti-pesticide**

# *IPM was developed for agriculture because....*

- No one method achieves long term pest management.
- Pest management is a part of plant care.
- Reduce costs.
- Failures, resistance, pollution were the lessons.





# *IPM Steps for Turfgrass*

- **Detection** of *what* is injuring turfgrass.
- **Identification** of agents injuring turfgrass.
- **Economic significance.**
- **Selection of methods.**
- **Evaluation.**





Detection



# *Detection-Monitoring*

## ■ Benefits:

- Discover pests present
- Determine life cycle stage
- Detect low level populations, So:
  - serious injury is prevented
  - more options are available
  - less toxic methods possible

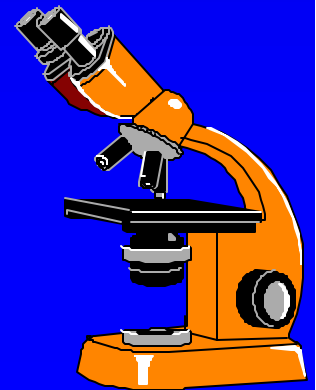
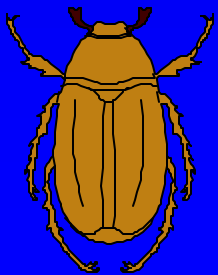

# *Scouting Techniques*

- Visual inspection
- Coffee can technique
- Disclosing solutions
- Turf roll-back
- Golf cup-cutter samples



# Visual Inspection





**coffee can technique**



disclosing solution



**Turf roll-back**



**Cup cutter**



# *Monitoring*

- Scouting
- Monitor weather
- Degree days (CAT Alerts)
- Phenology (Coincide)
  - Plant/pest development relationships

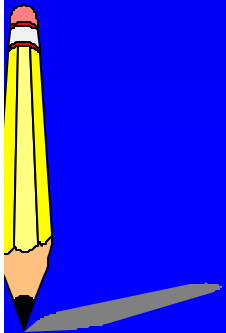
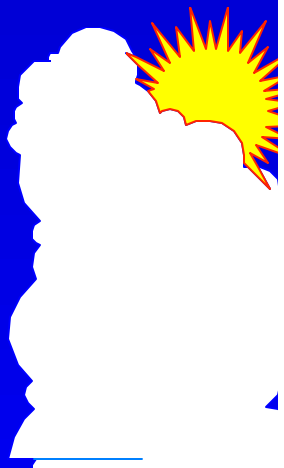

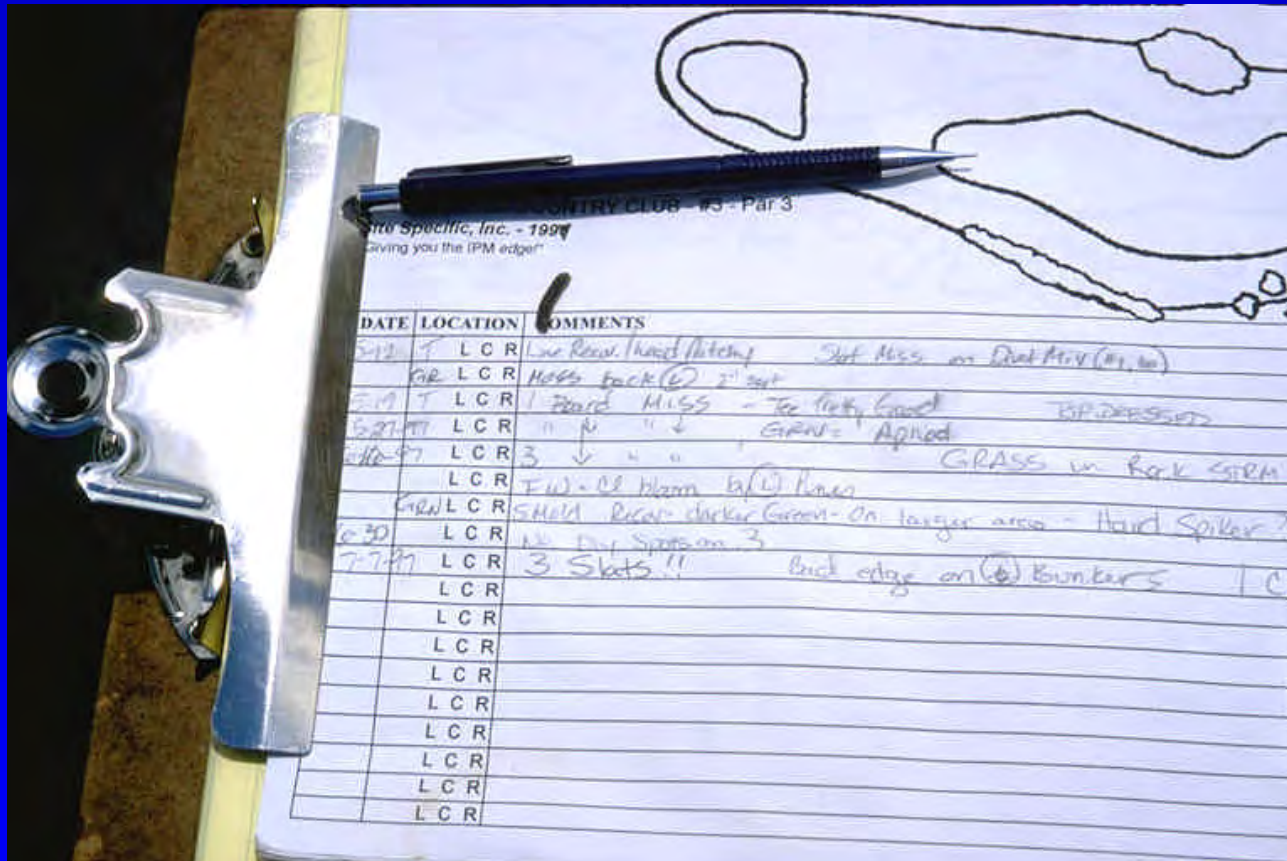

Create a standard sheet for recording monitoring data.

# ***Problem Identification***

- **Know healthy turfgrass**
  - **Species/variety**
  - **Growing requirements**



# ***Problem Identification***

- **Know the agents that damage turfgrass:**
  - **Cultural - environmental**
  - **Weeds**
  - **Diseases (fungal)**
  - **Insects**
  - **Animals**





# *Diagnosing Turfgrass Disorders*

- Symptoms
- Investigate the environment
- Turfgrass history
- Investigation tools
- References
- Diagnostic Lab
- Multiple causes possible

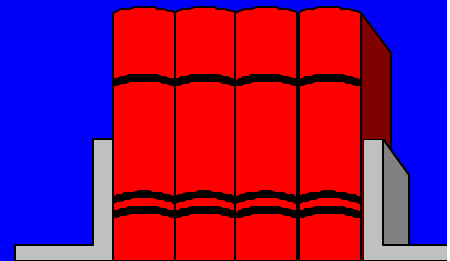
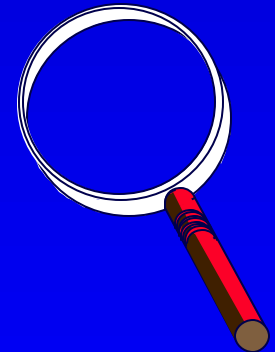

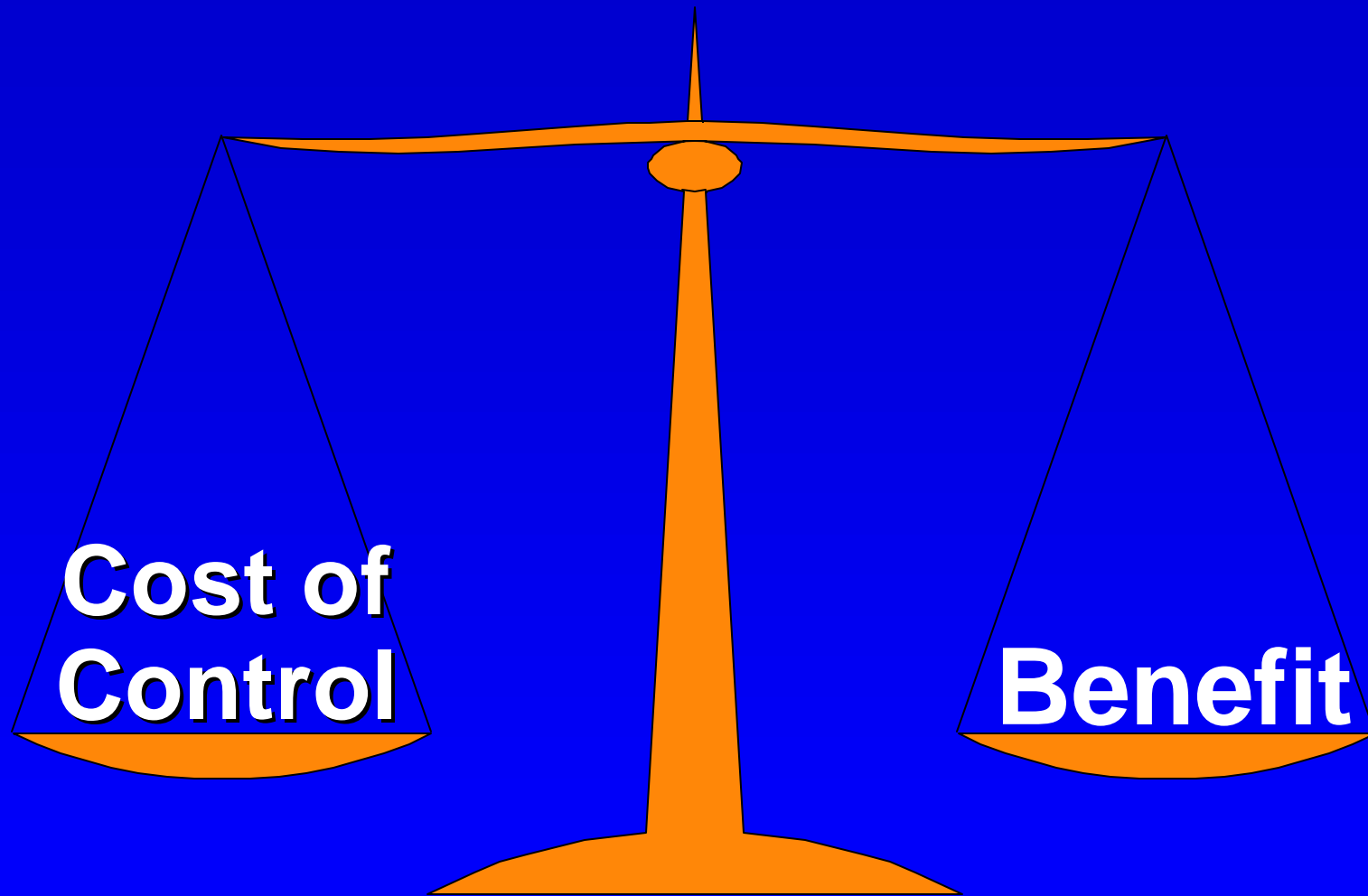

**Cost of  
Control**

**Benefit**

# *Economic Significance*

- **Economic injury level**

- Cost vs. benefit

- **Aesthetic injury level**

- unacceptable injury
  - Whose decision?

- **Action threshold**

- Pest level starting management action
- e.g., 5 grubs per square foot





# *Factors Affecting Injury Levels*

- Tolerance of pest damage
- Visibility or use of turf area
- Level of maintenance
- Health and vigor of the turf
- Greatest possible pest injury to the host
- Expected impact of natural controls



**Setting turfgrass injury levels that reflect specific pest and host conditions is the cornerstone of IPM.**



# ***Selection of Methods***

- **Many factors limit pest populations:**
  - **Weather**
  - **Natural enemies**
  - **Plant defenses**
  - **Controls implemented by people**

# ***Choose Control Methods...***

- **Least toxic to nontarget organisms**
- **Enhance natural controls**
- **May permanently limit the pest**
- **Least hazardous for the applicator**
- **Most likely to stay on the target area**

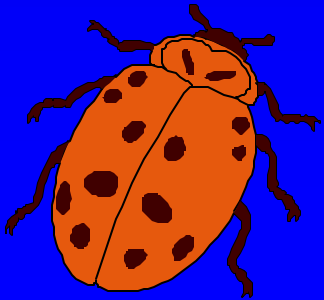
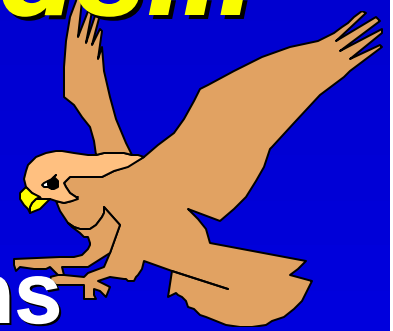

# ***Factors That Limit Options***

- **Budget**
- **Availability of equipment**
- **Availability of labor**
- **Time**
- **Availability of products**
- **Public/client acceptance of methods**

# *Evaluation*

- Was turfgrass protected from serious injury?
- Negative consequences?
  - Environmental impacts
  - Promotion of other pests
- Practical?
- Cost effective?

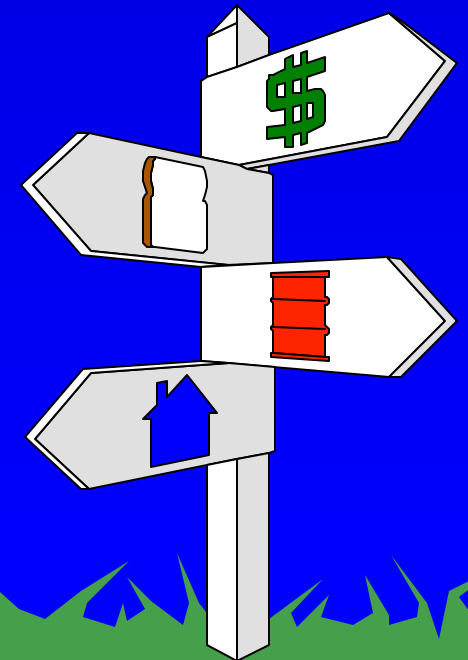



**Evaluate the results  
of management  
efforts.**

**Generate complete  
and accurate  
records.**

**Pests can't be maintained below threshold levels for long periods of time solely through the use of pesticides.**





**Practical, economical and environmentally sound pest management requires the use of all aspects of IPM.**



# *Turfgrass Pest Management (Category 3A)*

## **Care of Turfgrass Chapter 2**



MSUE Pesticide Education

# *Ecological Benefits of Turfgrass*

- Oxygen production
- Reduced erosion
- Pollutant absorption
- Reduced leaching
- Cooling
- Pesticide degradation

# ***Turfgrass Disorders: Non-Pest***

- **Improper species selection**
- **Lack of air movement**
- **Too hot, dry or wet weather**
- **Too much or not enough nutrients**

# ***Turfgrass Disorders: Non-Pest***

- **Soil compaction**
- **Competition from other plants**
- **Excessive wear or traffic**
- **Too much thatch**

# *Turfgrass Disorders: Non-Pest*

- Improper height of cut
- Too much or little sunlight
- Poorly maintained mower
- Improper irrigation

# *Turfgrass Disorders:* *Pest*

- Animal Pests
- Insect Pests
- Weeds
- Disease Pests

Pest problems are often the *result*, not the *cause*, of poor quality turf.





# *Requirements for Healthy Turf*

■ Water

■ Temperature

■ Sunlight

■ Soil organisms

■ Nutrients

■ Soil type and  
condition

**Water has the greatest influence on turf health and quality. Cooling takes place through transpiration.**



**Without sufficient water, I'll go dormant.**

# *Temperature & Climate*

## ■ Cool season grasses:

- Kentucky bluegrass, perennial ryegrass, fine fescues, tall fescue, bentgrass

## ■ Transition grasses:

- Tall fescue, bermudagrass

## ■ Warm season grasses:

- Zoysiagrass, bermudagrass, centipedegrass, bahiagrass



**Michigan is a cool -  
cold growing zone.**

**Shoot growth greatest  
between 60-75F.**

**Root growth optimum  
with soil temperatures  
between 50-65F.**

Temperatures above these ranges affect the entire grass plant.

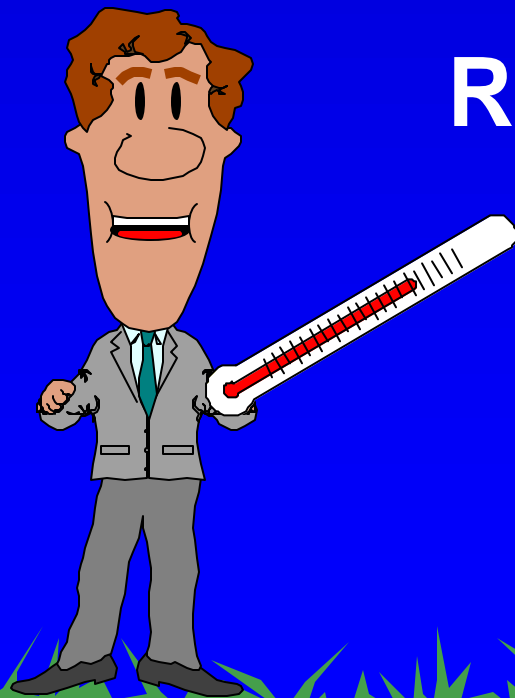

Respiration



Photosynthesis



=

**Energy Shortage**

# *Sunlight*

- Required for photosynthesis
- Species and cultivar preferences
- Most grasses require at least partially sunny sites



# *Shaded turf*



# *Soil Types*



# *Soil*

- **Soil is composed of:**
  - **Inorganic particles (minerals)**
  - **Organic matter (remains of organisms)**
  - **Water**
  - **Air**
  - **Soil organisms**

**An ideal soil contains:**

- **50% organic and inorganic solid particles, and**
- **50% open space (soil pores).**

**Pores are filled with water or air depending on soil type, drainage, and season.**

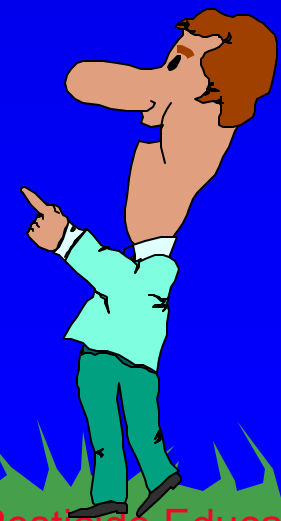

# *Soil Texture*

- Percentages of sand, silt, clay particles

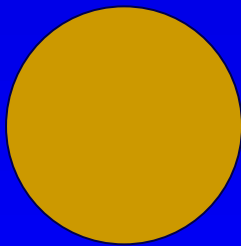

**Sand**



**Silt**



**Clay**



# *Sand*

- **Large particles & large pores**

- Limited water and nutrient holding capacity
- Limited compaction
- Rapid water infiltration

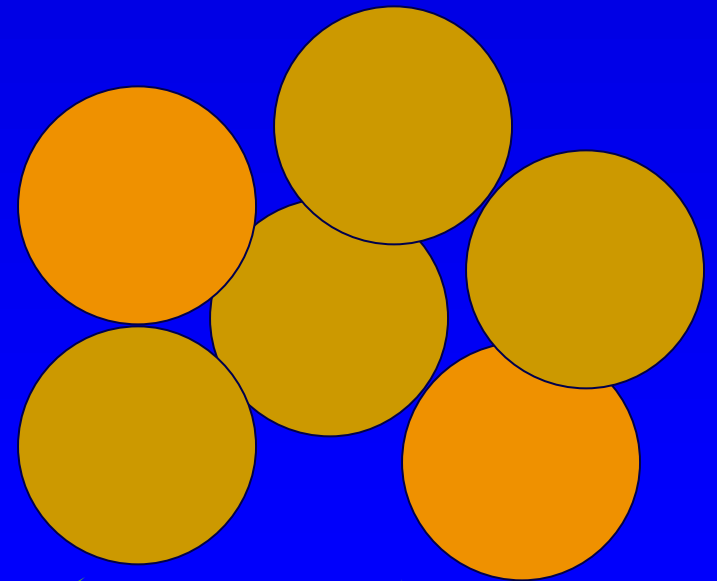

# *Clay*

- **Small particles & small pores**
  - **Compacts**
  - **Slow drainage & water infiltration**
  - **Holds moisture**
  - **Holds nutrients**
  - **Poor aeration**

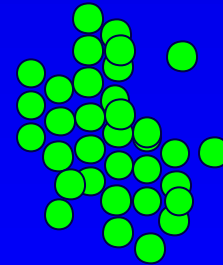

# *Ideal Soil*

- **Composite of soil particle sizes and organic matter with:**
  - **Good water and nutrient holding capacity**
  - **Good aeration**
  - **Resists compaction**

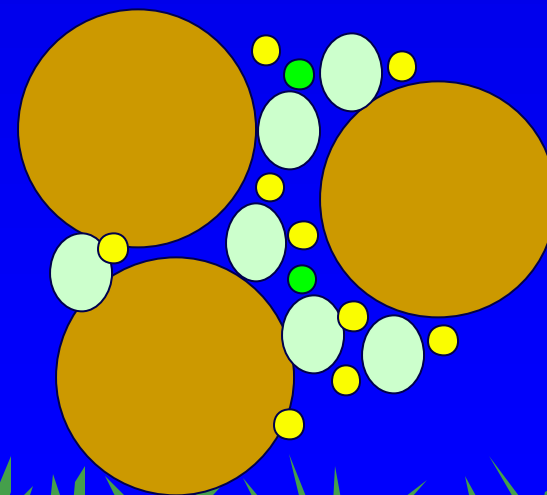

# *Soil pH*

- pH is a measure of soil acidity

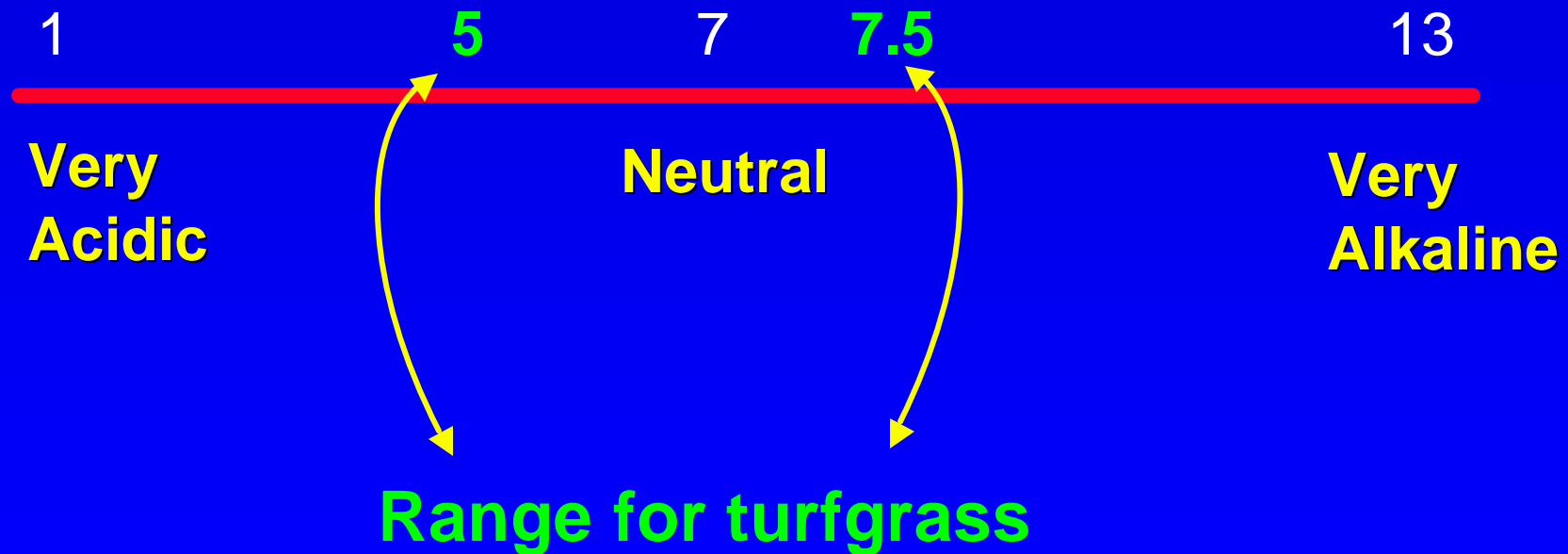

**pH affects nutrient availability.  
Determine pH with a soil test. Use  
lime to raise and sulfur to lower pH.**





# *Nutrients*

- Nutrient holding capacity determined by % of clay particles and organic matter.
- Nutrient levels constantly change in the soil.

**Even when you suspect turf is showing symptoms of nutrient deficiencies, soil testing is the only reliable method of diagnosis.**



# *Nutrients: Overview*

- Nitrogen (N)
- Phosphorus (P or  $P_2O_5$ )
- Potassium (K or  $K_2O$ )
- Micronutrients



# *Nitrogen*

- Used in largest quantities
  - Dry clippings are about 5% N by weight
- Turf most responsive to N
- Deficiencies:
  - Poor color, growth
  - Symptoms develop easily because N levels can change quickly

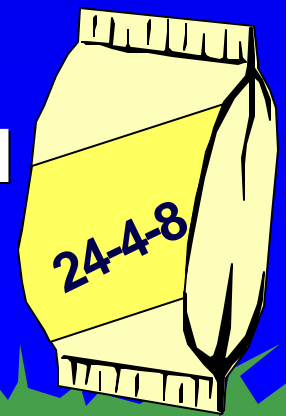

# *Nitrogen*

- Periodic applications needed for good quality.
- Do not exceed 1lb./1,000 sq. ft./appl.
  - Do not over apply nitrogen
  - Too much N = weak, lush turf
- N can move and contaminate water sources.

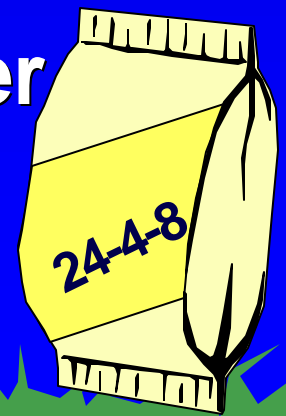

# *Phosphorus*

- **Important for:**
  - Root development, maturation, seed production
- **Practically immobile in the soil**
  - Few soils deficient in P
- **Deficiency: purpling of blades**
  - Do not confuse with cold weather coloration

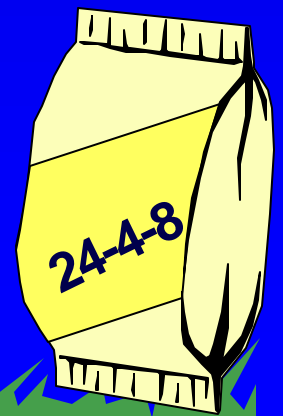

# *Phosphorus*

- Can move with soil particles into waterways.
  - Stimulates aquatic weed growth
- 50lbs./acre is adequate.
- Except for new turf, apply only when indicated by soil test.

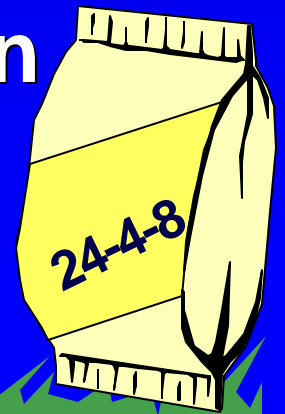

# *Potassium*

- Quantity used - second to N
- Important for:
  - Roots, wear, and stress tolerance
- Deficiency rarely visible
  - Yellow and dead blade tips
- 3:2 ratio of N:K commonly used
  - Visual response: minimal

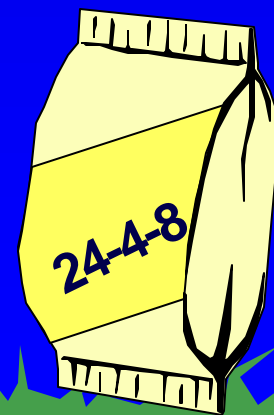



# ***Micronutrients***

- **Used in small amounts**
  - Iron, copper, manganese, etc..
- **May be limiting with pH above 7**
  - e.g., iron deficiency
  - Iron applications provide short term benefits

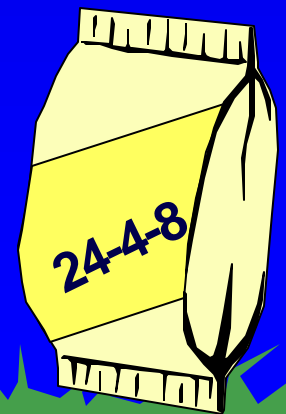

# *Soil Organisms*

- **Contribute to organic matter**
- **Aerate the soil**
- **Process nutrients**
- **Degrade pesticides**



# Establishing Turf

**Prevent chronic problems by carefully selecting and installing turfgrass.**



**Select grasses suited to growing conditions and planned use. Many varieties of Kentucky bluegrass, perennial ryegrass and fine fescue are suitable for MI conditions.**



# *Grasses*

- **Species and varieties differ in:**
  - **Appearance**
  - **Wear tolerance**
  - **Maintenance requirements**
  - **Pest susceptibility**
  - **Site tolerance**

**Turf stands composed of several grass types are better able to resist pests and adapt to different environmental conditions.**



## ■ Blend:

- 2 or more grasses of the same species
  - ✦ Glade + Bristol + Cheri Kentucky bluegrasses

## ■ Mixture:

- 2 or more different species
  - ✦ Kentucky bluegrass + perennial ryegrass

# Fungi Endophytes

**Some fescue and ryegrass varieties contain a fungus that is toxic to insects chewing on the plant.**





# *Planting Procedures*

- Eliminate weedy perennial grasses
  - Quackgrass, bentgrass
- Rough grade to correct slope
- Amend soil if needed
- Analyze soil
  - Adjust nutrients and pH

# *Planting Procedures*

- Work soil to depth of 6 inches
- Remove stones and debris
- Smooth grade area
- Apply starter fertilizer
- Plant:
  - Late summer is best
- Rake, mulch, water the seedbed

# *Post-Planting Care*

- Watering
- Mowing
- Fertilizing
- Pest management



**Healthy Turf**



# *Watering*

- Amount and frequency depends on weather conditions.
- Keep moist - NOT wet.
- Decrease amount and frequency as roots develop.



# *Mowing*

- Mow as soon as desired height is passed.
- Keep blades sharp and properly adjusted.
  - Dull blades may pull up seedlings

# *Fertilizing*

- A couple of weeks after seedlings emerge or roots develop, apply 1/2 rate of 2-1-1 ratio fertilizer.
- Be sure to include K.
- Water in fertilizer to prevent burning.

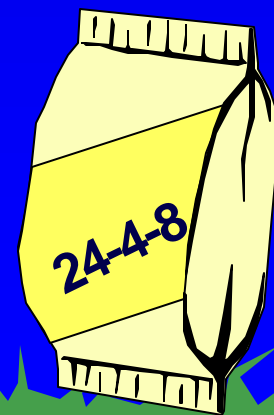

# ***Pest Management***

- **Young turfgrasses can be sensitive to pesticides.**
  - **Delay applications until established**
  - **Use alternative strategies**
  - **If a pesticide must be used:**
    - ♦ **Check label for rates on newly established turfgrass**

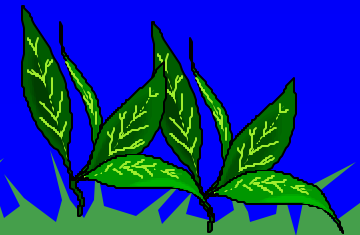

# *Maintaining Turf*

## ■ Requires:

- Watering
- Mowing
- Fertilizing
- Aerating
- Dethatching
- Pest management

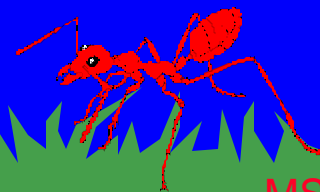



**Management practices must reflect the needs of the grasses, site conditions, and use objectives. Excessive maintenance may be wasteful or damaging.**



## **Watering**

**Too much? Too little? How often? When? Rainfall? Irrigation? Dormant?**

**No consensus, no simple answers.**



# Evapotranspiration

The amount of water lost by transpiration and evaporation from the turfgrass stand.

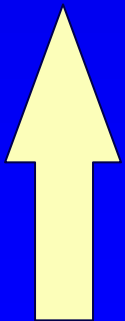

1 inch per week



**No single irrigation method meets season-long needs of a turfgrass stand. Make adjustments to keep the root zone moist, not saturated.**

**Daily, light irrigation (1/5"/day) has been shown to be effective.**





# *Irrigated turf*

# *Mowing*

## ■ Height

- 2-3 inches for most turf
- Mowing short...
  - ✦ reduces root growth & vigor
  - ✦ increases weed invasion

## ■ Frequency

- No more than 1/3 removed per cut

## ■ Enduring drought

- Increase height of cut
- Mow during cool hours-not when wilted

# Grass Clippings

**“Don’t Bag Them”**



**Clippings do NOT contribute to thatch.**

**Recycle plant nutrients.**

**Keep pesticides on the lawn.**

**When clippings are removed, fertilization should be increased by 25-50%**





# *Fertilization*

## ■ Consider:

- Species and varieties of turfgrass
- Site conditions
  - ✦ Sun, shade, wet, dry, soil type, slope
- Utilization of the site
  - ✦ Wear, utility, “picture perfect”

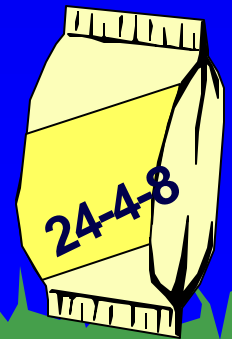

# *Fertilizer Characteristics*

- Water solubility
- Slow release
- Synthetic or “natural organic”
- Soil reaction effects
- Burn potential
- Fertilizer analysis
  - Complete: 21-4-8

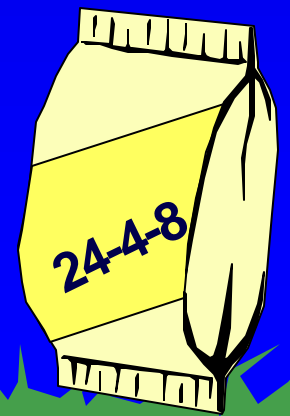



# *Fertilizer burn*

# *Fertilizer Burn*

- Don't apply to wet or stressed turf
- Apply evenly
- Don't spill
- Use granules or pelleted vs. pulverized
- Water-in soluble fertilizers
- Use insoluble, organic forms
- Apply no more than 1 lb./1,000 sq. ft. per application



**Clay soils  
drain poorly  
and easily  
become  
compacted.**

# Aeration

Relieves compaction, stimulates root growth.

Core aerators more effective than spike or slit aerators.

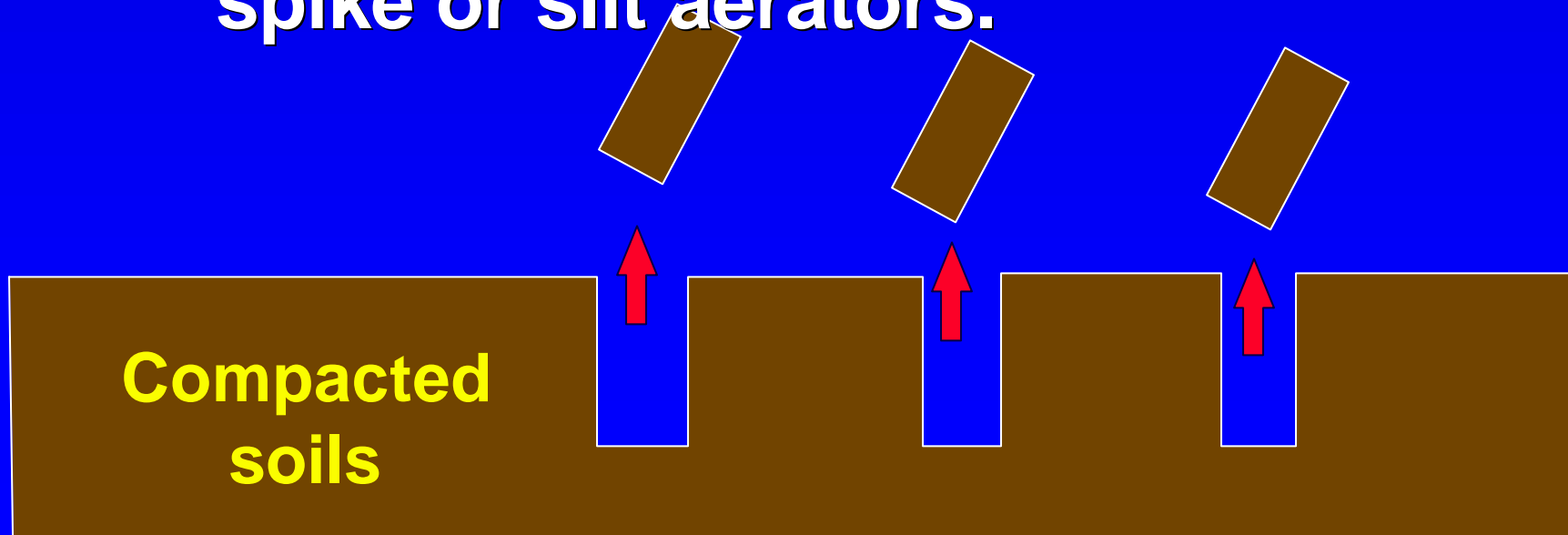

# *Thatch*

- **Exists between green vegetation and soil surface.**
- **Tightly intermingled living and dead stems, leaves, roots.**
- **A thin thatch layer:**
  - **Reduces compaction**
  - **Moderates soil temperature and reduces water loss**

# *Thatch*

- Too much - over 1/2 inch:
  - restricts water, nutrient, pesticide and air movement
  - may encourage disease & insect pests
- High N and rapid growth may encourage thatch formation
- Pesticide use may increase thatch



# *Thatch Reduction*

**Coring and processing the soil back into the thatch is the best way to reduce thatch.**

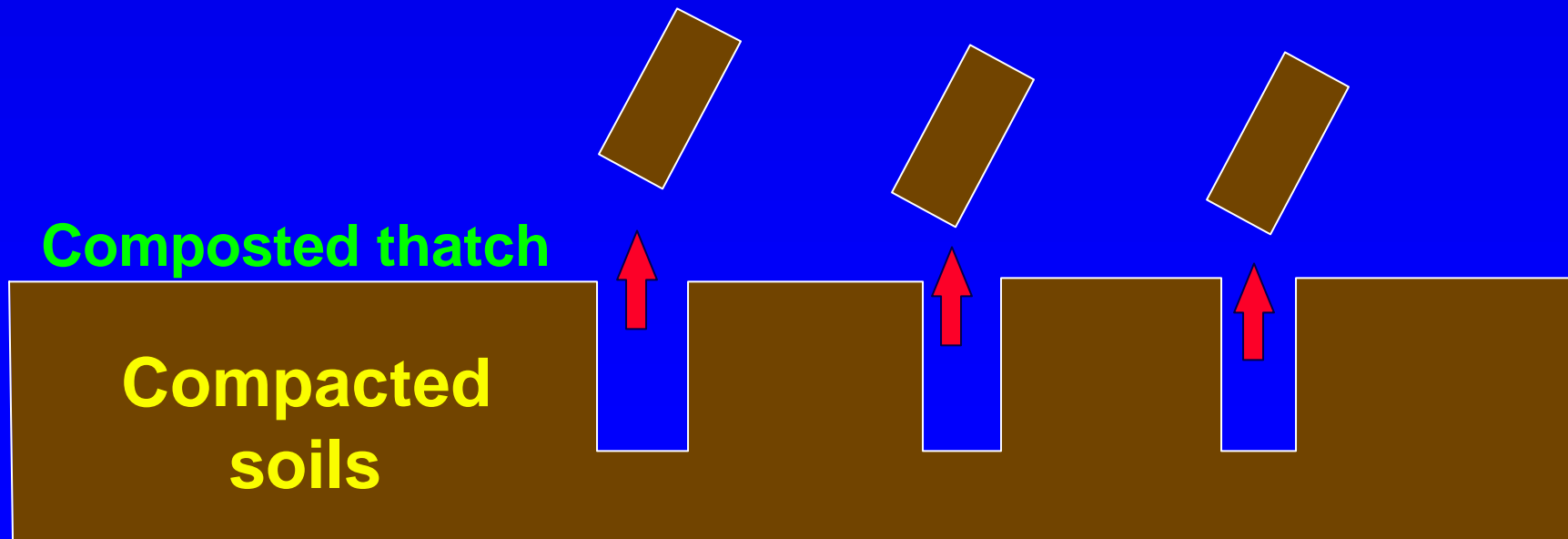

# *Shaded Turfgrass*



## ■ Satisfactory

- rough bluegrass, fine fescue

## ■ Fair

- tall fescue, perennial ryegrass

## ■ Poor

- Kentucky bluegrass

## ■ Varieties make a difference

# *Shaded Turfgrass*

- Tree and shrub roots compete for water and nutrients.
- Tree canopies = umbrella.
- High humidity can increase disease.
- Suggestions:
  - Trim trees, reduce fertility, use tolerant grasses, mow high, irrigate carefully
  - Plant ground covers



***Turfgrass Pest  
Management (Category 3A)***

**Pest Management  
Techniques**

**Chapter 3**

# *Pest Management Tactics*

■ Short term suppression

OR

■ Long term maintenance of pest levels

- Resistance
- Environmental modifications
- Cultural practices
- Biological controls



# *Short Term Suppression*



- Fungicide application for control of Rhizoctonia - Brown patch.

# *Long-term maintenance*

- Environmental modifications
- Cultural practices
- Resistance

# *Plant Resistance = Plant Vigor*

## ■ Plant selection

- Match site conditions
- Pest resistance

## ■ Established turf

- Modify environment
- Appropriate cultural practices



# *Cultural Practices*



Topdressing

# *Cultural Controls*

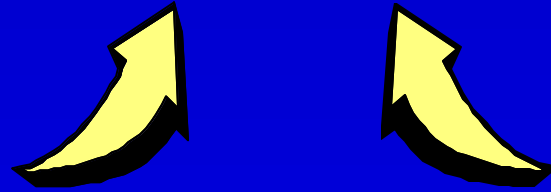

- Irrigation
- Drainage
- Fertility
- Aeration
- Reduce shade
- Increase air movement
- Sanitation
- Mowing



# *Mowing*



# *Mechanical & Physical Controls*

## ■ Hand Removal

- Cutworms, slime mold

## ■ Traps

- Moles, skunks, wood chucks, etc.

## ■ Barriers

- Roots

## ■ Repellants

- Vertebrates

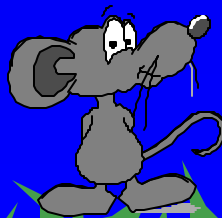



# *Spider and wasp*



# *Chinch bug and Big-eyed bug*

# *Biological Controls*

- Encourage natural enemies
  - Limit pesticide use
  - Select “friendly” pesticides
  - Prevent unacceptable injury
  - Do not attempt pest eradication

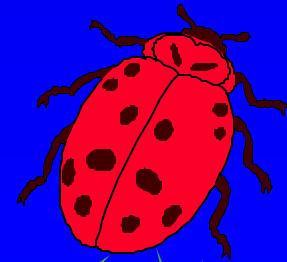

# *Biological Controls*

- **Increase natural enemies**
  - **Insect release**
    - **Predators, parasites**
  - **Pathogen based insecticides**
    - **Bt**
    - **Naturally occurring**





*Bt for control  
of cutworms*



***Turfgrass Pest  
Management (Category 3A)***

**Pesticide Application  
Chapter 4**

# *Thinking applicator*

# *Selecting a Pesticide*

- Labeled for the pest or site.
- Produces desired level of control.
- Least disruptive to the environment.



# *Selecting a Pesticide*

- Non-phytotoxic.
- Economically practical.
- Compatible with turf management.
- Acceptable to the public.



# *Classifying Pesticides*

- Type of pest controlled.
- Pesticide chemistry.
- Mode of action.
- Pesticide formulation.

**To use any pesticide in a manner inconsistent with its label is a violation of federal and state law.**



# *Type of Pest Controlled*

- Insecticide → Insects
- Acaricide → Mites and ticks
- Nematicide → Nematodes
- Fungicide → Fungi
- Rodenticide → Rats and rodents
- Avicide → Birds
- Herbicide → Weeds



**Toxicity**  
**Category**

**LD50**

**Signal Word**

I	Up to 50 mg/kg	<b>Danger</b>
II	51-500 mg/kg	<b>Warning</b>
III	501-5,000 mg/kg	<b>Caution</b>
IV	> 5,000 mg/kg	<b>Caution</b>

Select “Caution” pesticides  
when possible and avoid  
RUP’s!

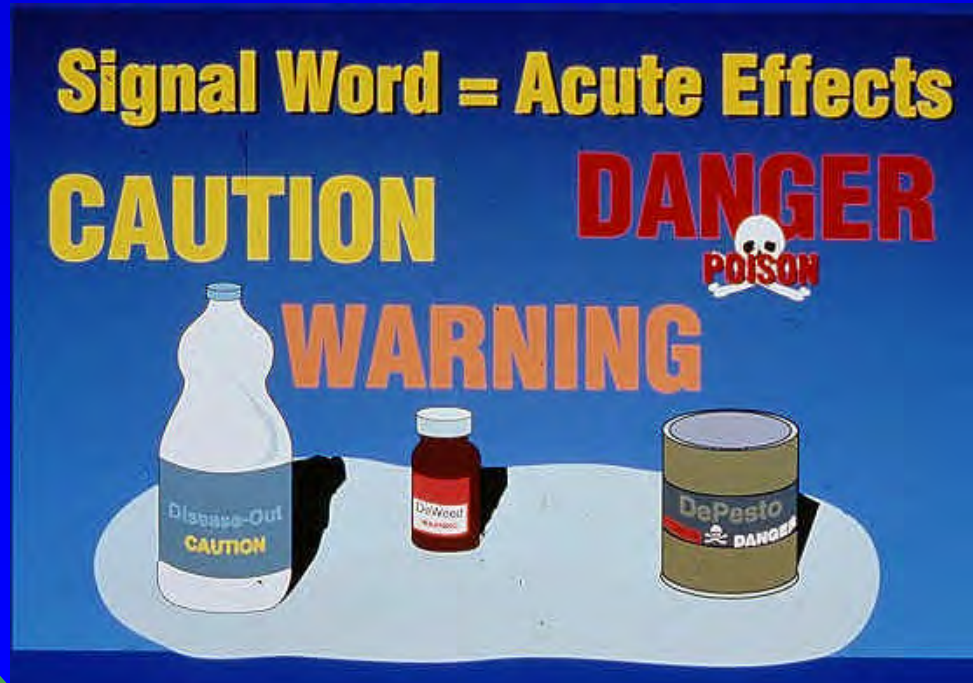
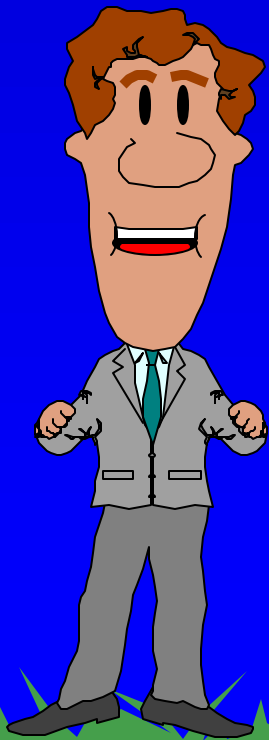

# *Pesticide Mode of Action*

- Broad spectrum
- Residual pesticide
- Protectant
- Systemic
- Contact
- Nonselective herbicide
- Selective Herbicide

# *Pesticide Formulations*

## ■ When selecting, consider:

- Application method
- Ease of storage and mixing
- Risk when handling
- Risk of moving off target
- Cost

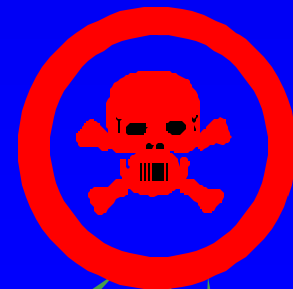

# *Pesticide Formulations*

- Emulsifiable Concentrates: E, EC
- Wettable Powders: WP
- Soluble Powders: SP

- Flowable: F, L
- Granules: G
- Baits



**Be familiar  
with your  
equipment  
specifications.**



# *Pesticide Application Equipment*

- Granular spreaders
- Spray output equipment
- Controlled droplet (CDA)
- Small-capacity sprayers
- Hydraulic sprayers



# *Granular Spreaders*

- **Drop (gravity) spreaders**
  - pattern= width of spreader
  - uniform coverage or target area
    - ◆ abrupt edges
- **Rotary spreaders**
  - coverage wider than spreader
    - ◆ overlap required for uniformity
    - ◆ drift to nontarget areas





# *Spray Equipment*

- Traditional spray guns
- Shower head gun
  - Large droplets
  - Low pressure
- Spray wand
- Spray booms



# *Spray Nozzles*

- **Nozzles are classified by:**
  - Spray delivery pattern
  - Spray angle
  - Discharge rate
  - Construction material
- **Nozzles used outside of specified rates and pressure will not work accurately.**

# *Nozzle Types*

- Flat pattern
- ✓ Uniform when boom is at proper height.

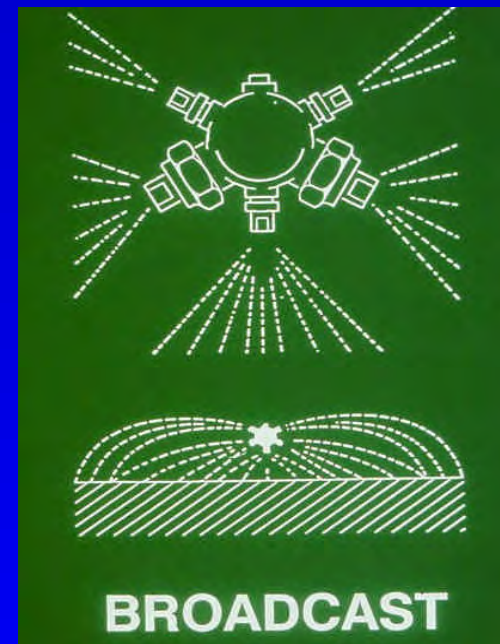
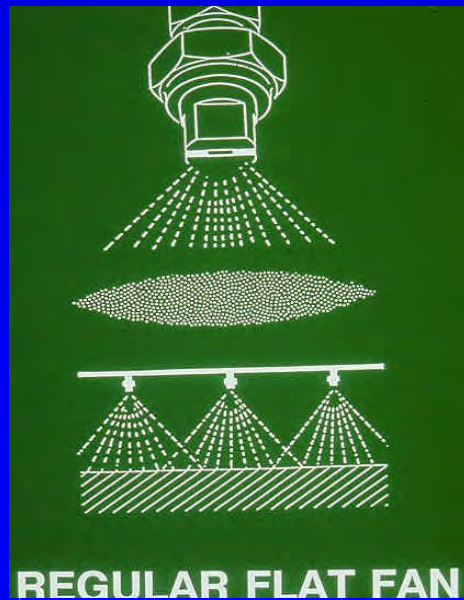

- Broadcast pattern
- ✓ Not uniform.

# *Nozzle Types*

## ■ Flooding fan

✓ Not as uniform as flat fan.

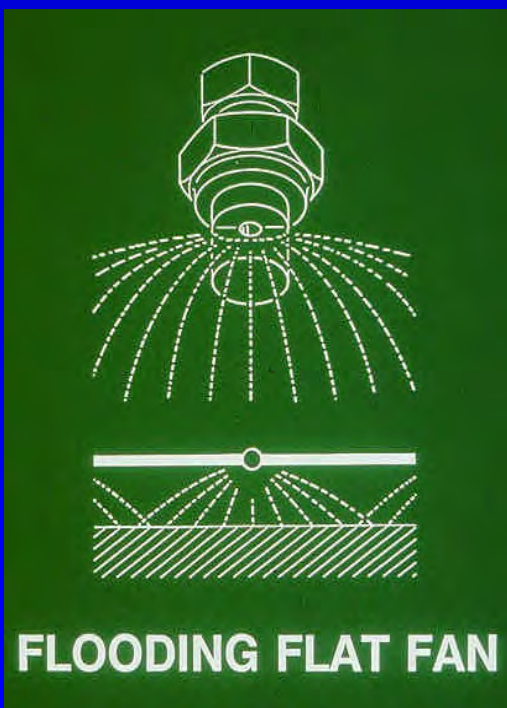

## ■ Hollow cone

✓ Best for direct spraying not boom.

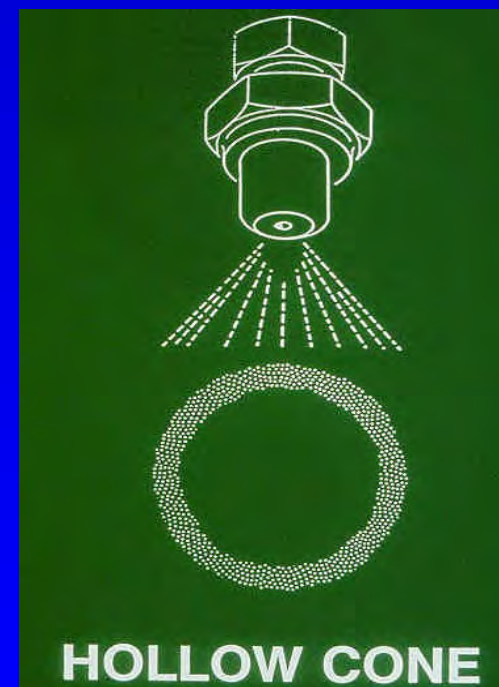

**Abrasive materials, like wetttable powders, cause nozzles to wear. Worn nozzles alter application rates. Calibrate, check, and replace worn nozzles.**



# *Controlled Droplet Applicators*

- **Commonly called:**
  - Rotary spray nozzles or spinning disk
- **Droplet size is uniform; varies with:**
  - Cup diameter
  - Speed
  - Flow rates
- **Uses limited water.**

# *Small-Capacity Sprayers*

- **Used for small areas and spot treatments:**
  - Most are hand sprayers
  - Most use compressed air
  - May have a wand, gun, small boom
  - Tank pressure drops as solution is sprayed
  - Minimal agitation -- WPs settle

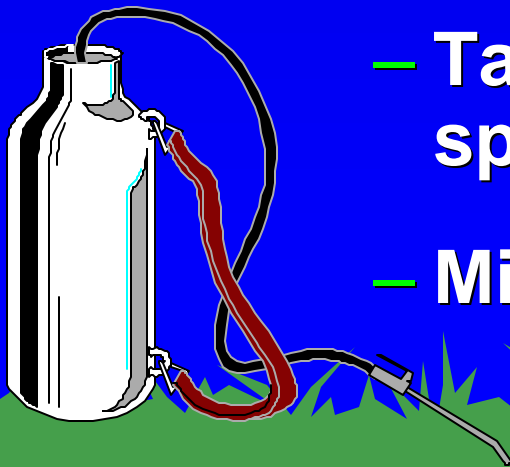

# *Hydraulic Sprayers*

- Used for most large scale applications.
- Spray material delivered through:
  - Hand held gun
  - Boom
- High and low pressures possible.
- Large capacity tanks available.





***How*** you apply a pesticide is equally as important to pest management as your choice of the pesticide product and application equipment.



**Apply *Only* the amount of pesticide necessary to obtain the desired level of pest control.**

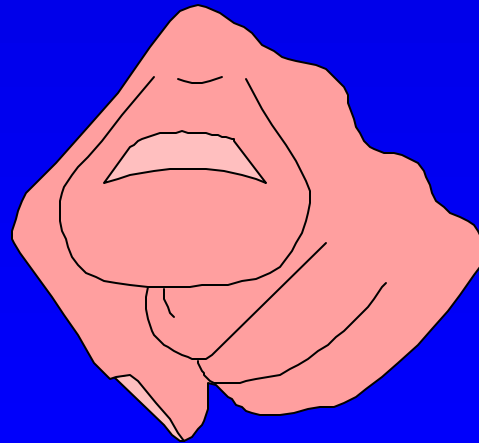

# *Application Techniques*

- Apply only where pests are located.
- Don't allow activities to reduce effectiveness:
  - ✦ Rain, not watering-in, etc.
- Tailor applications to pest habits:
  - ✦ Water-in grub control materials

# *Applying Granular Products*

- Fill equipment on paved surface.
- Make “header” strips around the property.
  - Keep material off paved surfaces and out of flower beds
- Treat property with parallel swaths.
  - Use correct overlap
  - Turn off spreader before header strip

# *Applying Granular Products*

- Keep spreader level.
- Walk at consistent pace.
- Don't stop without shutting off spreader.
- Don't operate backwards
  - Application may change



# Operating & Maintaining Sprayers



# *Before Spraying*

- Put on protective gear.
- Rinse and clean system.
- After filling, check for leaks.
- Adjust equipment according to recommendations and label.
- Limit drift.
- Check for uniform output.

# *During Spray Applications*

- Wear protective gear.... label.
- Operate according to owner's manual.
- Check for nozzle clogging or pattern changes.
- Clean nozzles with a soft tool, not metal.
- Never unclog a nozzle by blowing through it.



# *After Spraying*

- Flush hoses, tanks, nozzles.
- Wipe off residues.
- Clean equipment before:
  - Making repairs
  - Switching pesticides
- Check operation and repair.
- Re-use rinse water.
- Do not use herbicide-designated equipment for other applications.

# *Applying Pesticide Sprays*

- Point showerhead nozzle away from legs and feet.
- Do not drape hose around neck or waist.
- Concentrate on accuracy:
  - Walking speed, pressure, pattern.

# *Applying Pesticide Sprays*

- Spray in parallel swaths.
- Use straight edges as a starting guide.
- Maintain straight walking lines.
- Maintain proper overlap.
- “Trim” margins:
  - Margins only receive 1/2 rates and need an adjusted application.

# *Pesticide Record Keeping Regulation 636*

- Address of application
- Name and concentration of pesticide
- Amount of pesticide
- Target pest or purpose
- Method and rate of application

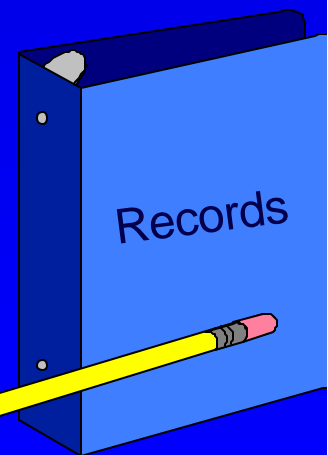

# *Pesticide Record Keeping*

Keep general use pesticide application records for at least one year, and keep RUP application records three years.



**Other  
helpful  
information  
may  
include...**

- Name of applicator
- Certification number
- EPA registration number
- Date of last calibration
- Time of application
- Weather conditions
- Specific treated area
- Target pest stage



# Pesticide use record sheet.

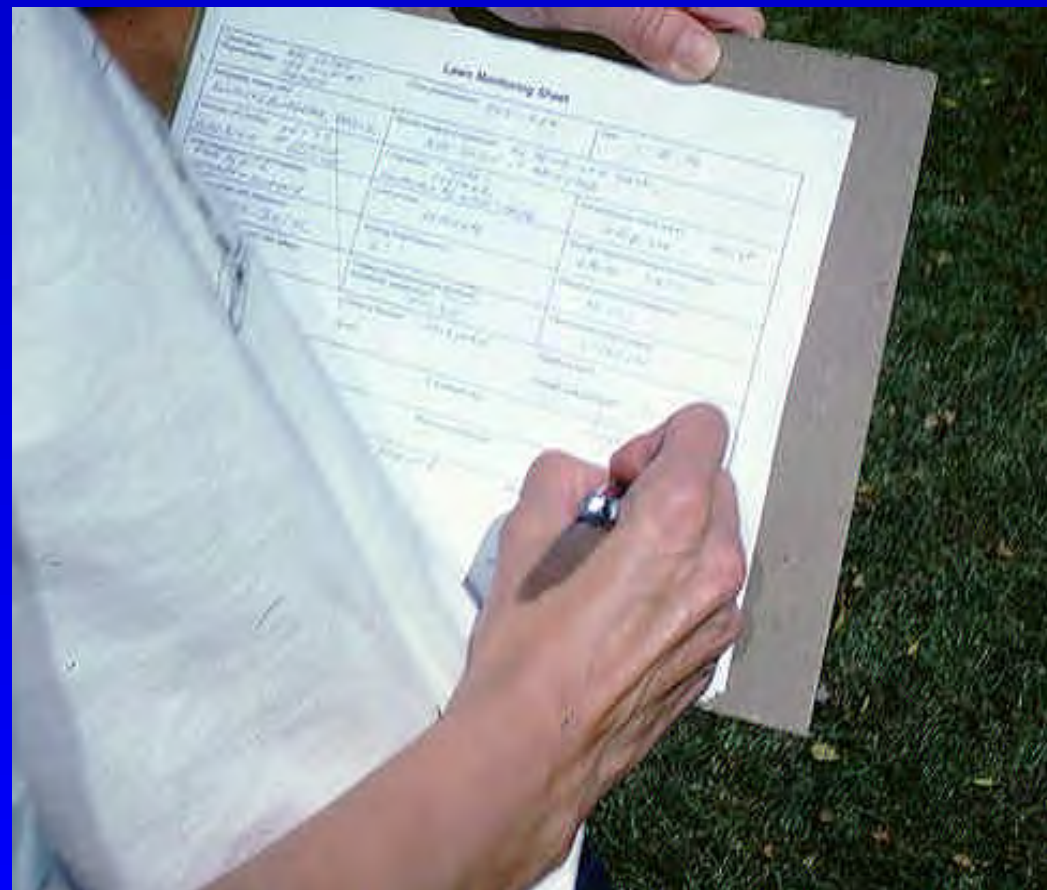

***Turfgrass Pest  
Management (Category 3A)***

**Application Calculations  
and Calibration**

**Chapter 5**



**Accurately mixing pesticides  
& calibrating equipment is  
critical to successful pest  
management.**

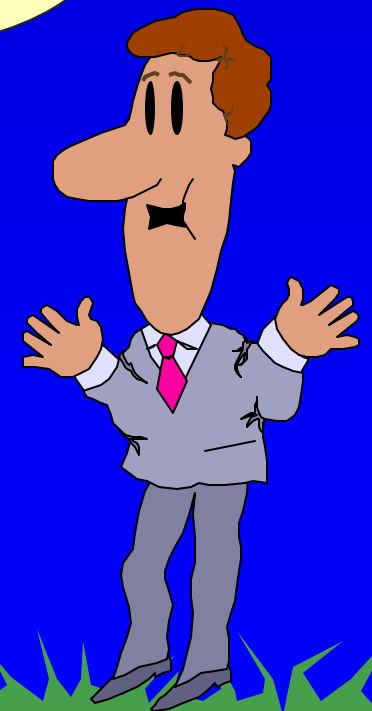
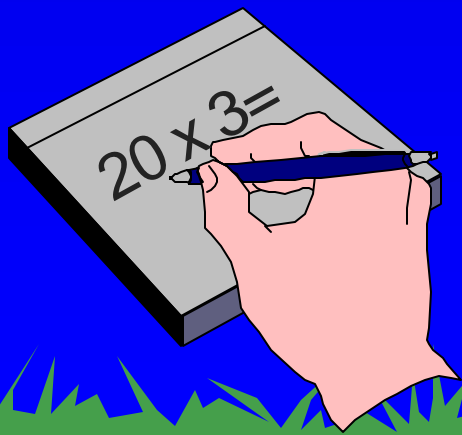

# *Area Measurement*

- Method 1: Divide & Conquer
- Method 2: Offset Lines
- Method 3: Average Radius

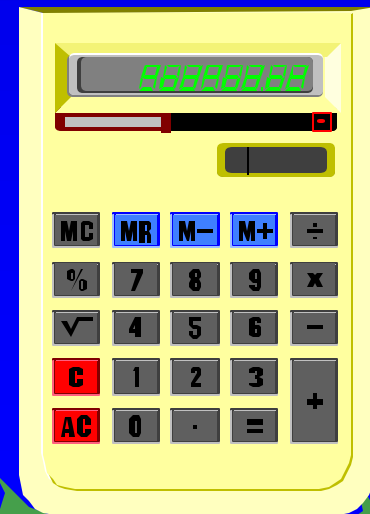

# *Method 1: Divide & Conquer*

- Divide irregular shaped areas into groups of simple shapes that can be added together.

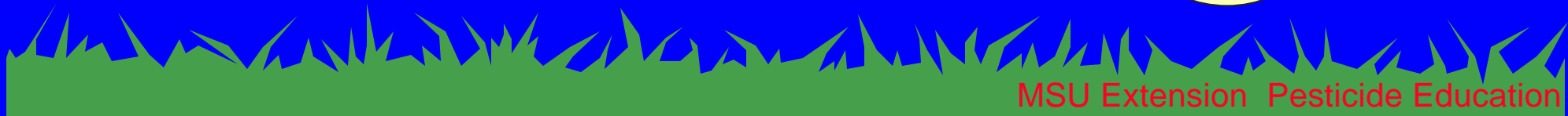
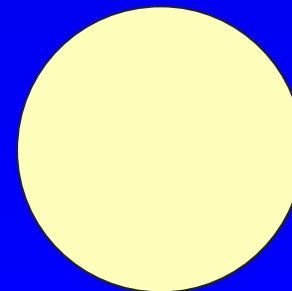
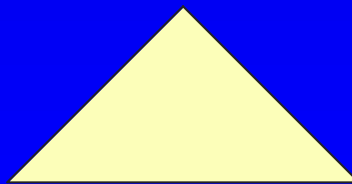
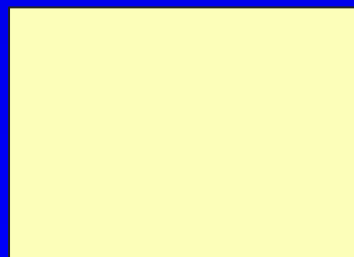

**W =**  
**50 ft.**

**Area = length x width**

**L = 100 ft.**

**Area = 100 ft. x 50 ft. = 5,000 sq. ft.**

**200ft.**

**A trapezoid is a 4-sided figure with 2 parallel sides.**

**Area = Ave. length of parallel sides x height**

**50 ft.**

**300 ft.**

$$\text{Area} = (200 + 300)/2 \times 50 = 12,500 \text{ sq. ft.}$$

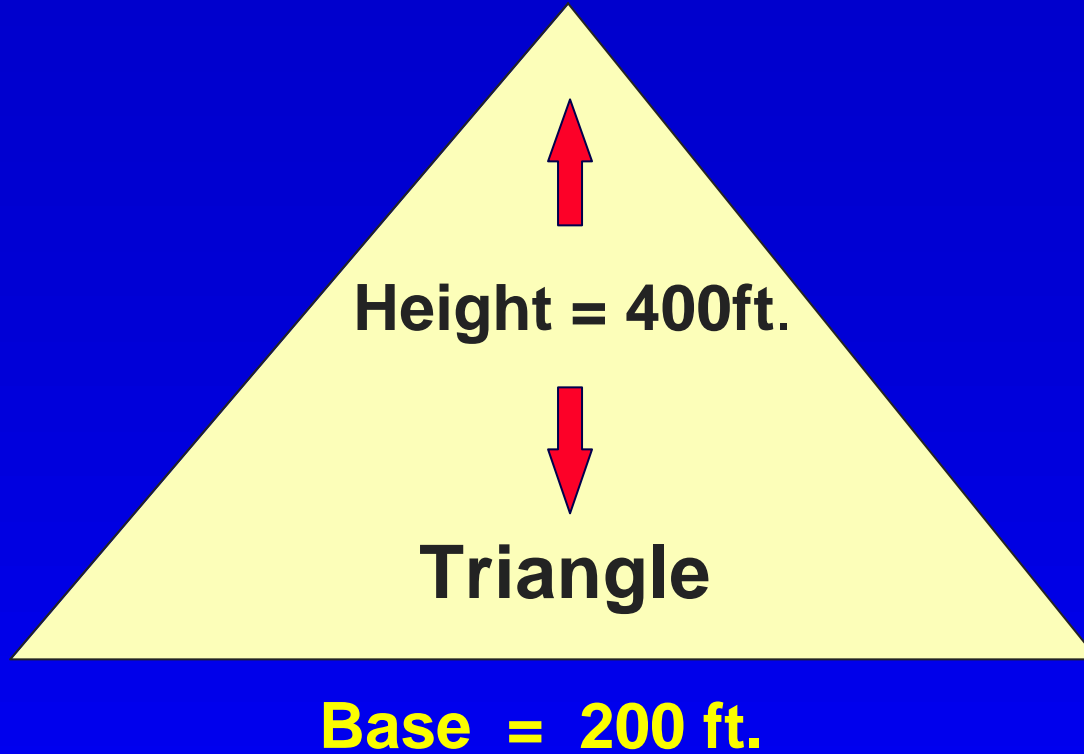

**Area of a triangle = height x base/2**

**Area = 400 x 200/2 = 40,000 sq. ft.**

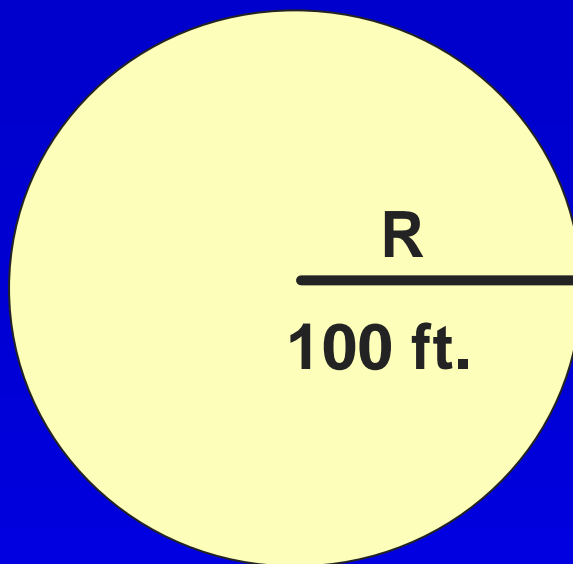

**The radius (R) of a circle is 1/2 the diameter.**

**$3.14 = \pi = \text{pi}$**

**Area = Radius x Radius x 3.14**

**Area = (100 x 100) x 3.14 = 31,400 sq. ft.**

# Coping with Irregular Shapes

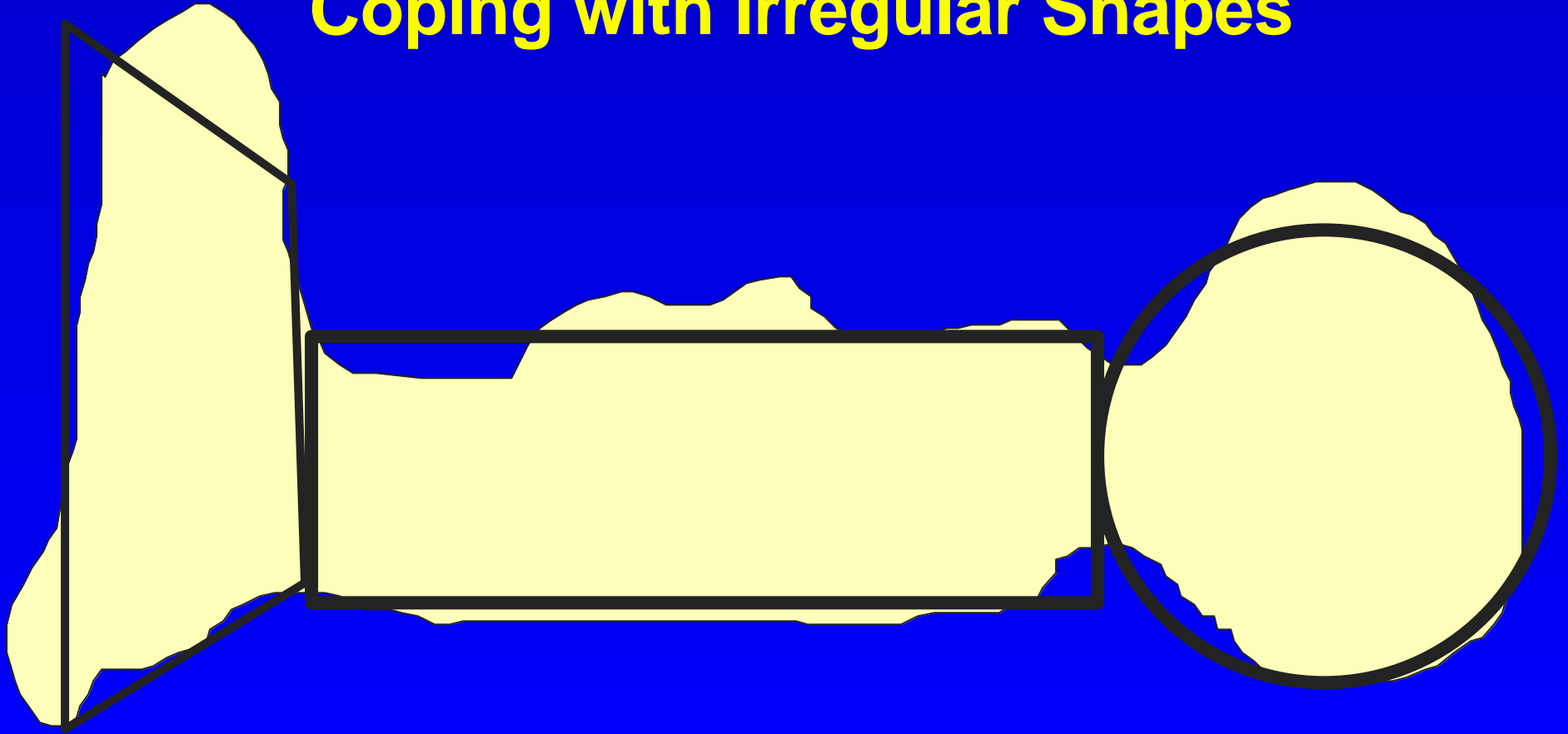



# *Method 2: Offset Lines*

900 ft.

90 ft

offset line

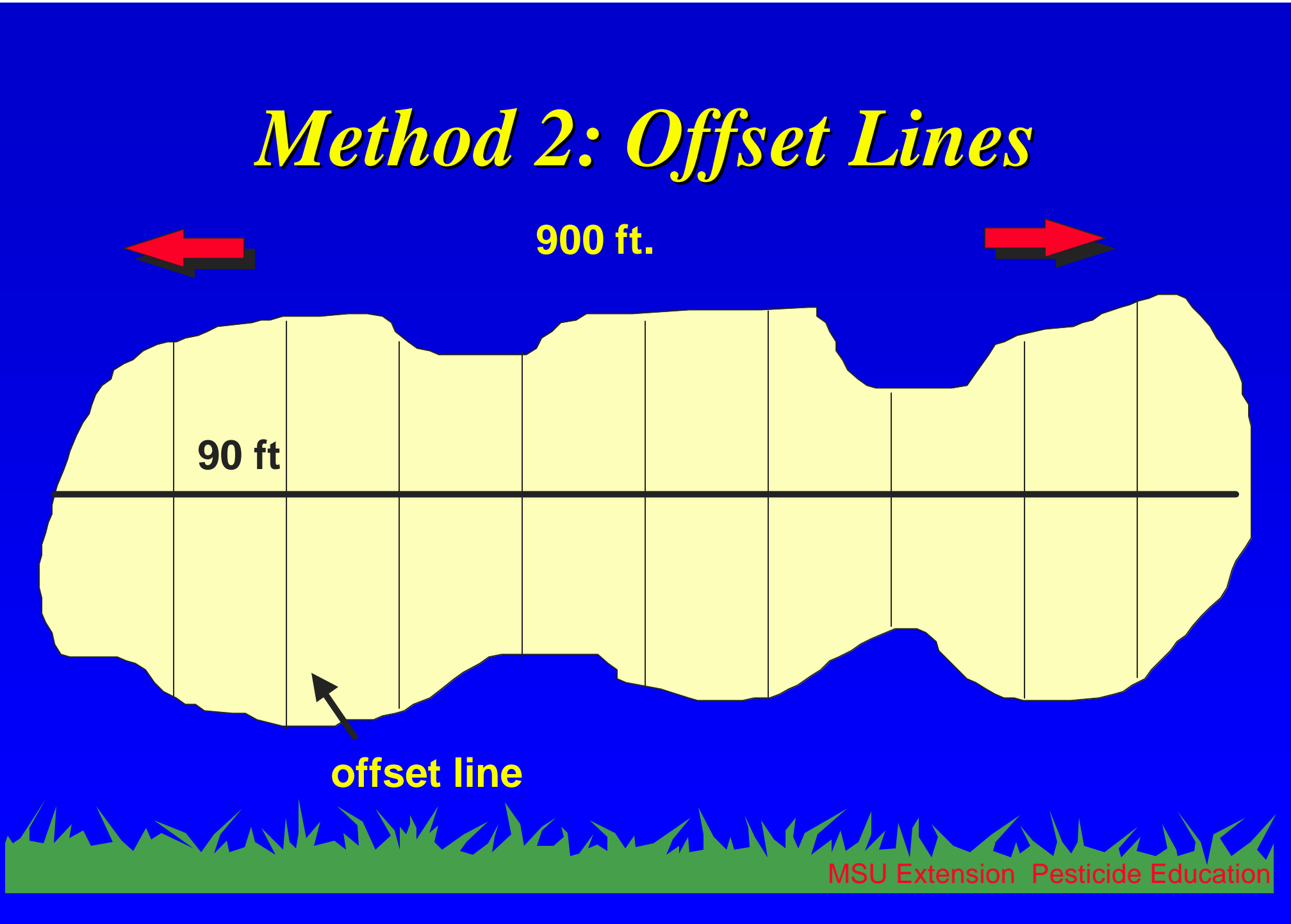

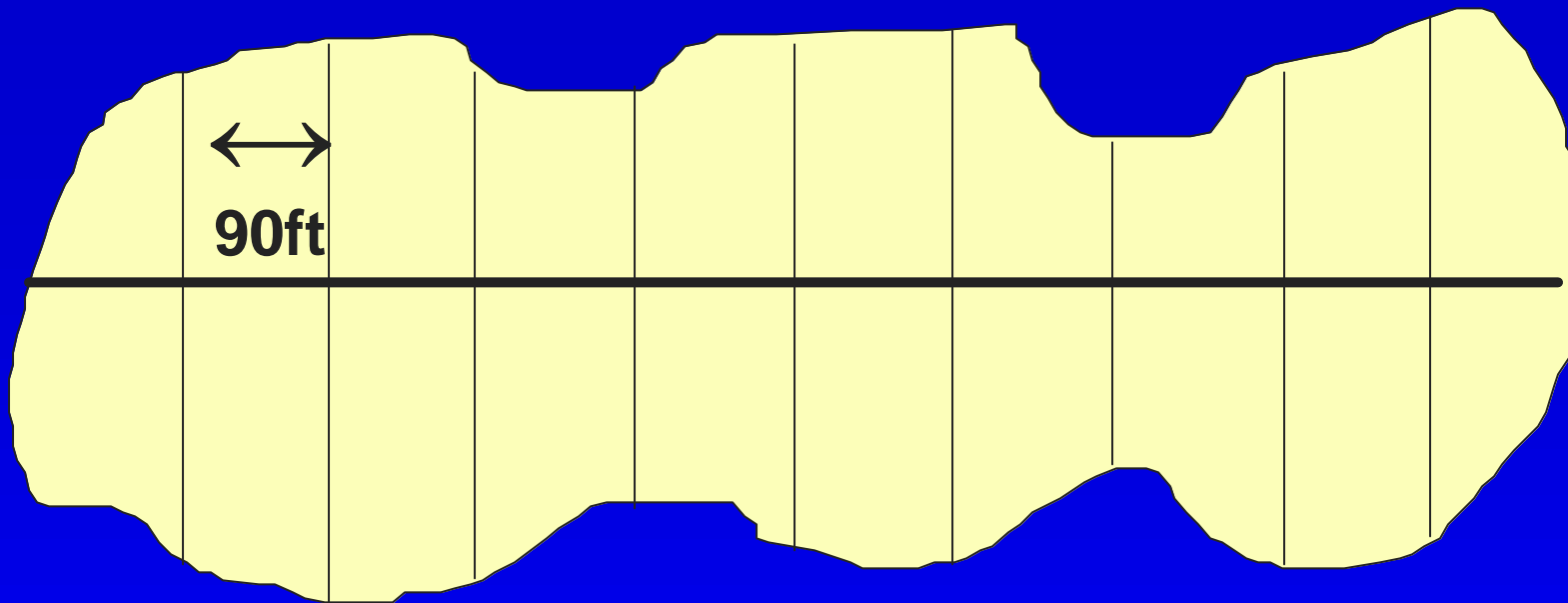

**Area = sum of offset lengths x distance  
between offsets**

**Area = 1,155 ft. x 90 ft. = 103,950 sq. ft.**

## ***Method 3: Average Radius***

**Converts irregular area into a circle**

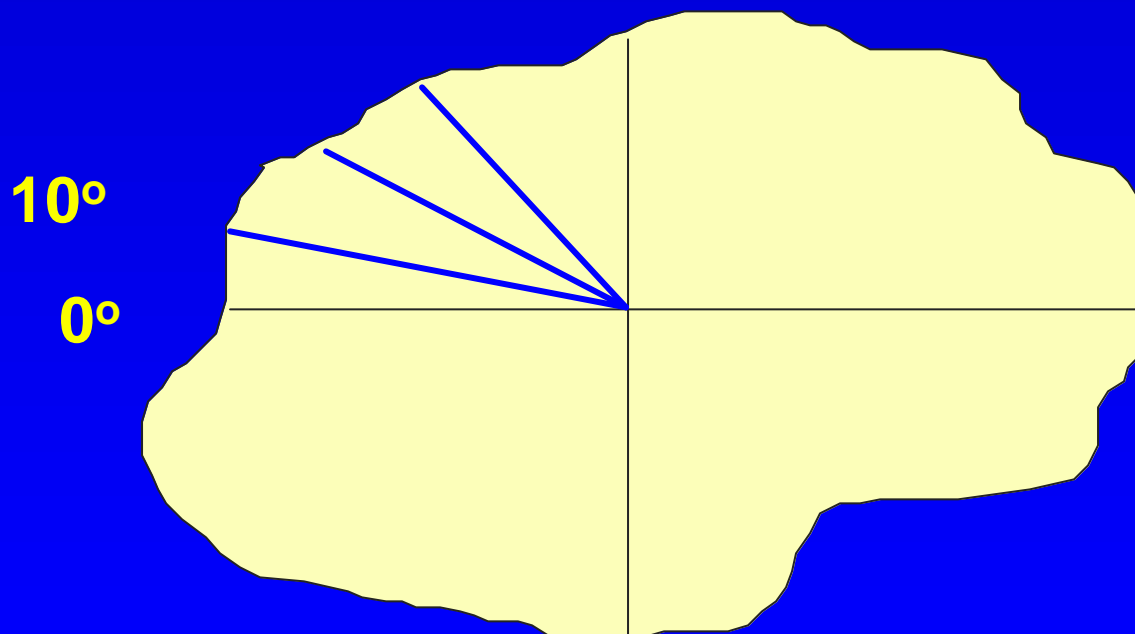

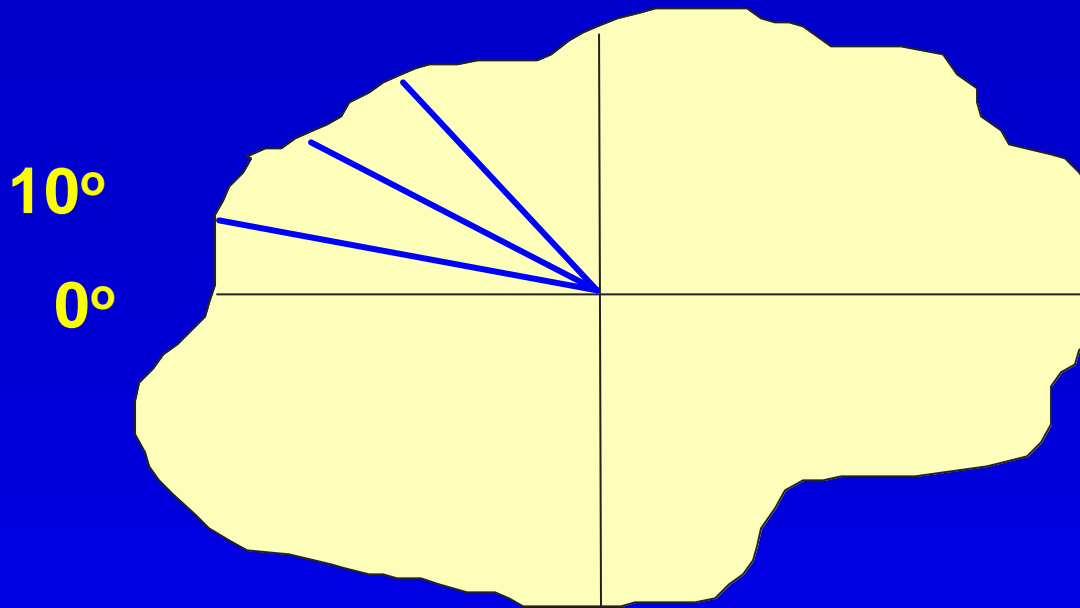

**Take measures (radius) every 10 degrees.**

**Area = (sum of radii/number of radii)<sup>2</sup> x 3.14**

**Start.... 1,731.6ft / 36 = 48.1ft.**

**Area = 48.1ft. x 48.1 ft. x 3.14 = 7, 264.7 sq. ft.**

# *Calibrating*

## **Application Equipment**



Drop and rotary spreaders are the two most common granular spreaders used by the turf industry.

# *Spreader Output*

- Size of the meter opening determines flow of the material from the spreader.
- Rate of flow through opening is affected by:
  - granule weight, size
  - shape, carrier material

**You must recalibrate when  
you change from one  
material to another.**

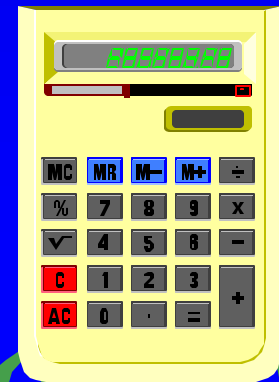



**Ground speed must be consistent.**

**Doubling the ground speed does not always double the application rate!**



# *Calibration: Method 1*

- Use pan to catch output
- Set suitable test course
  - similar terrain
  - 50 ft. long
- Cover course and catch output
  - weigh caught material
- Calculate area of the test course

# *Calibration: Method 1*

- Weight of material caught/area of test course = amount per sq. ft.
- Amount per sq. ft. x 1,000 = application rate per 1,000 sq. ft.
- Application rate should be within + or - 5% of the labelled rate.

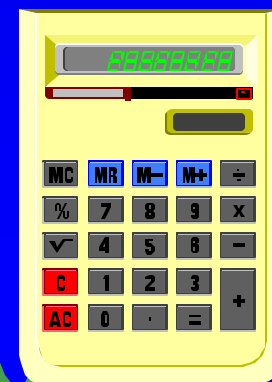

# *Calibration: Method 2*

- **Cover test area with plastic or similar material.**
- **Gather and weigh product applied on test area.**
- **Calculate as with method 1.**

# Example

**You recover 4.75 lbs. of material from the test course. Your rotary spreader has a swath width of 8 ft. Test course 40 ft. long. What is the application rate per 1,000 sq. ft.?**

# Example

Test course is 40 ft. x 8 ft. = 320 sq. ft.

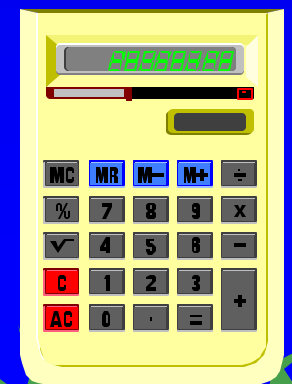

# Example

Application rate per 1 sq. ft. is:

$$4.75 \text{ lbs.} / 320 \text{ sq. ft.} = .01484 \text{ lbs.}$$

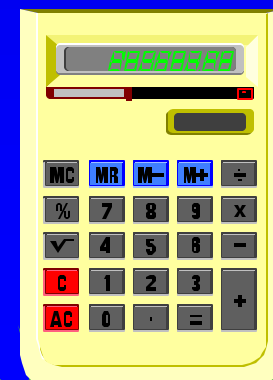

# Example

Application rate per 1,000 sq. ft. is:

$$.01484 \text{ lbs.} \times 1,000 = 15 \text{ lbs.}$$

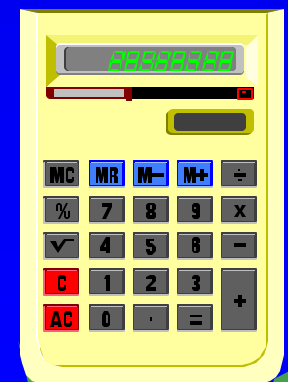



# Example



**If the label states this product should be applied at 9 lbs. per 1,000 sq. ft., is your application rate acceptable?**

# Example

First, find what 5% of 9 lbs. Is:

$$.05 \times 9 \text{ lbs.} = .45 \text{ lbs.}$$

+ or - 5% = 8.55 to 9.45 lbs.

15 lbs. is over 5 lbs. too much

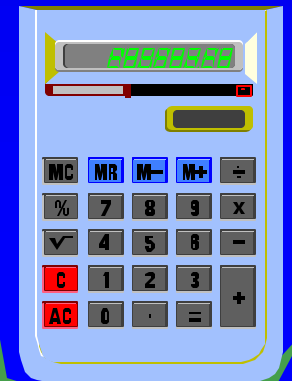

**You must adjust the  
orifice and recalibrate.**

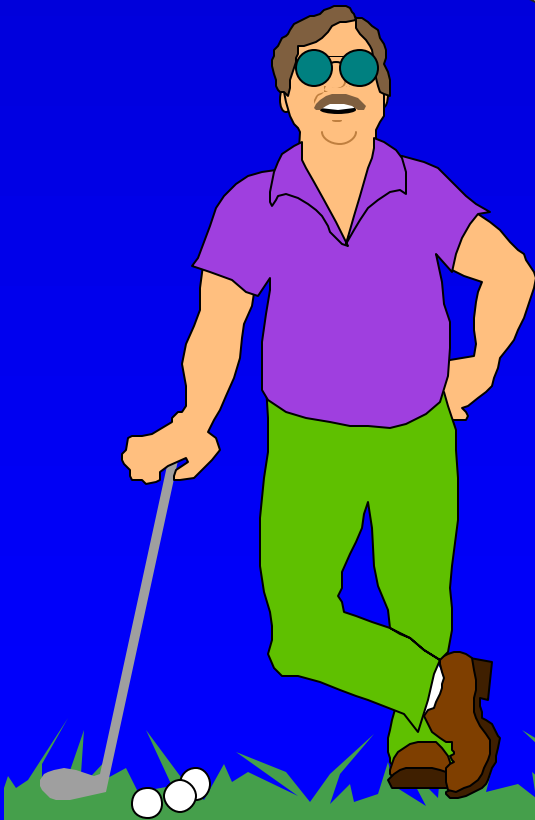

# *Sprayers - Key Factors...*

## ■ Involved in proper delivery and calibration:

- ground speed
- pressure
- output
  - ◆ orifice size

# *Ground Speed*

- Double the speed =
  - 1/2 the application.
- Calibrate on similar terrain to application area.
- Bouncing equipment can vary application rates by 50%.

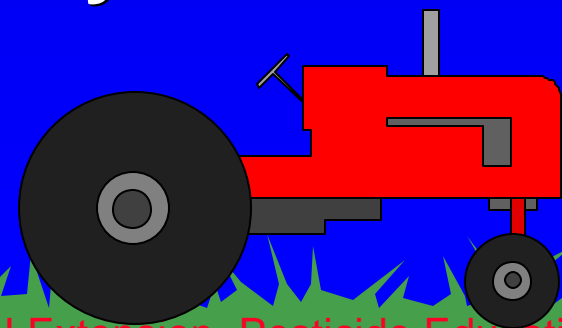

# *Pressure*

- Changing pressure does not affect application rates like speed.
  - to double the rate, pressure must be increased 4x.
- Equipment is designed to work within certain guidelines.
- Long hose runs reduce pressure.

# *Output*

- **Output is determined by pressure and type of nozzle.**
  - check with equipment suppliers for technical information on nozzle selection.
- **Once the nozzle and pressure are determined, the calibration process can begin.**

**There are many methods used to calibrate sprayers. Find one you are comfortable with and use it often.**





# *Small Manual Sprayers*

- Flow difficult to regulate because pressure changes constantly.
  - applications requiring a consistent flow are **not** recommended.
  - appropriate for “% solutions” applied as “spray until wet.”

# *Shower Head Nozzles*

- Accuracy depends on:
  - Uniform “swing” pattern with consistent and smooth hand motion.
  - Consistent walking speed.
  - Practice.
  - Equipment operating with manufacturer’s guidelines.

# *Showerhead Nozzles*

## ■ Calibration

- **Step 1:** Determine the output per 1,000 sq. ft. that is appropriate for the job based on product label, type of application and equipment used.

# *Showerhead Nozzles*

## ■ Calibration

- **Step 2:** Mark off a test course at least 40 ft. long and determine your swath width. Calculate the area in square feet of your test course.

# *Showerhead Nozzles*

## ■ Calibration

- **Step 3:** Spray the test course with water using the technique you will use during the actual application. Always begin spraying before entering the test course.

# *Showerhead Nozzles*

## ■ Calibration

- **Step 4:** Record the number of seconds required to spray the test course. Average 3 test applications together for accuracy.

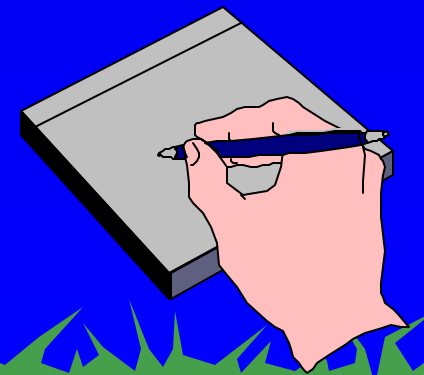

# *Showerhead Nozzles*

## ■ Calibration

- **Step 5:** Determine the volume of water applied to the test course by spraying into a bucket for the number of seconds required to cover the test course. Measure this output in gallons.

# *Showerhead Nozzles*

## ■ Calibration

- **Step 6:** Divide the number of gallons collected by sq. ft. of the test course. This is the gallons applied per sq. ft. Convert to gallons per 1,000 sq. ft. or acre. **This is your output.**





# *Showerhead Nozzles*

## ■ Calibration

- **Step 7:** Make any necessary changes in nozzles, walking speed, or pressure to achieve acceptable output. Recalibrate.
- **Step 8:** Calculate the amount of pesticide to add to the tank.

**Example:** Your test strip is 40 ft. long with a 6 ft. swath width. You sprayed the **240 sq. ft.** course in an average of 45 seconds. You sprayed **1.25 gallons.** What is the output per 1,000 sq. ft.?

$$1.25 \text{ gal.} / 240 \text{ sq. ft.} = .0052 \text{ gal. per sq. ft.}$$

$$.0052 \text{ gal.} \times 1,000 \text{ sq. ft.} = 5.2 \text{ gal per } 1,000 \text{ sq. ft.}$$



# *Backpack Sprayers*

- Should have pressure gauge or a pressure regulator to maintain a constant pressure.
  - Use “ounce” method.
  - Use “showerhead” method.

# ***Boom Sprayers***

- **Determine consistent output and pattern from all nozzles. Replace:**
  - **Nozzles not delivering with + or - 5% of the average output.**
  - **Nozzles not delivering a uniform pattern.**
- **Set pressure according to manufacturer.**

# *Ounce Method*

Distance Between Nozzles (inches)	Test Course Length in Ft.
10	408
12	340
14	291
16	255

**Ounces dispensed = gallons applied per acre**

# ***Pesticide Calculations***

**You need to spray 10 acres of turf.**

**Your boom sprayer has a 100 gal. tank and is calibrated to apply 75 gal. per acre.**

**Rate for the pesticide is 2 qts. per acre.**

**How much spray mix per acre, and how much pesticide is added per tankful?**

# *Pesticide Calculations*

**Total spray mix = 75 gal per acre x 10 acre = 750 gal**

**Area covered by one tank full is 100 gal./75 gal per acre = 1.33 acres**

**Pesticide per tank = 1.33 acres per tank x 2 qts per acre = 2.66 qts. per tankful**

**Suggestion: Consider using ratios to solve calculation problems. No formulas to remember! Logical!**

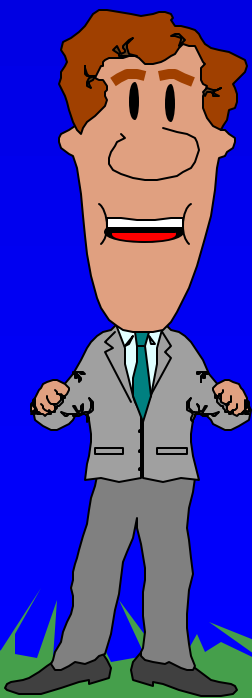

$$\frac{75 \text{ gals.}}{2 \text{ qt}} = \frac{100 \text{ gal}}{x}$$

$$75x \text{ gal} = 200 \text{ gal qt}$$

$$75x = 200 \text{ qt}$$

$$x = 200\text{qt} / 75$$

$$x = 2.66 \text{ qt}$$



***Turfgrass Pest  
Management (Category 3A)***

**Pesticide Safety**

**Chapter 6**



**Contact the MDA or MSU Extension to  
keep current with changing pesticide rules  
and regulations!**

**Read the label before  
selecting and applying  
any pesticide.**

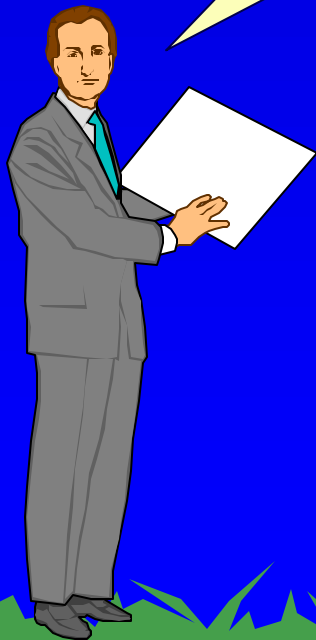

# *Applicator Safety*

- You must comply with label guidelines
- Clean, service or replace gear regularly
- Wash gear and yourself
- Wear more gear with frequent applications or if pesticide-sensitive
  - **Minimum:** gloves, face and eye protection when mixing, plus hat and respirator for overhead applications.

# *PLCAA Protective Gear Recommendations*

## ■ Filling and Mixing:

### – Dry fertilizer only

- ◆ dust mask or respirator with dust filter

### – Pesticides

- ◆ goggles/face shield, head gear, apron, boots, gloves, full respirator with dust filter when mixing powdered pesticides

### – Hand cans

- ◆ gloves

# *PLCAA Protective Gear Recommendations*

## ■ During Application:

### – Fertilizer only:

- ◆ boots, gloves

### – Insecticides or liquid slow release N:

- ◆ boots, gloves, goggles (when high pressure spraying)

# *PLCAA Protective Gear Recommendations*

## ■ Handling Spills:

- Wear all protective clothing and equipment recommended for the material spilled.



# *Applicator Cholinesterase Level*

- For users of carbamate and organophosphate insecticides
- Off-season baseline level required
- Testing program implemented by a doctor





**Review PLCAA Cholinesterase Testing Recommendations for more specific information. Talk to your doctor or medical advisor.**



# Pesticide Poisoning

Most poisonings result from accidents, careless or ignorant use!

But even careful applicators may be exposed!



**The best defense  
against harm is to  
be prepared!**

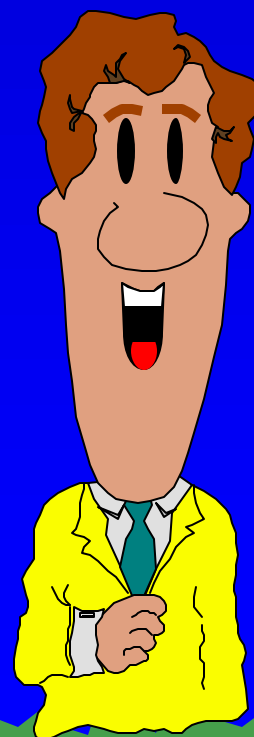

# *First Aid & Safety Materials*

- Pesticide label
- MSDS
- Syrup of Ipecac
- First aid kit
- Eye wash
- Detergent
- Clean water
- Rubber gloves
- Change of clothing
- Spill absorbent
- Fire extinguisher
- Poison Center phone #
- Hospital contacts
  - phone #
  - doctor
  - directions

# *Poisoning Symptoms*

## ■ Vary with:

- type of pesticide
- where exposed
- amount absorbed
- health of individual

## ■ Onset of symptoms can happen:

- suddenly
- slowly

**Remember, poisoning symptoms can be similar to other ailments such as heat exhaustion, asthma or food poisoning.**

**\*Never give alcohol!**

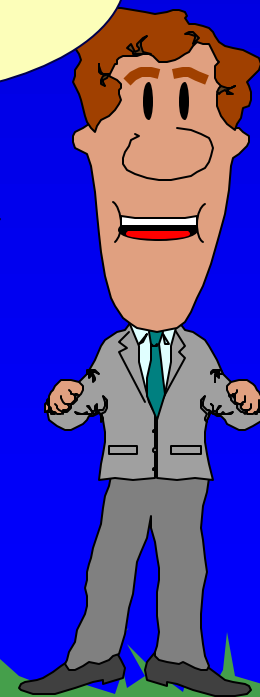

# *Symptoms of Pesticide Poisoning*

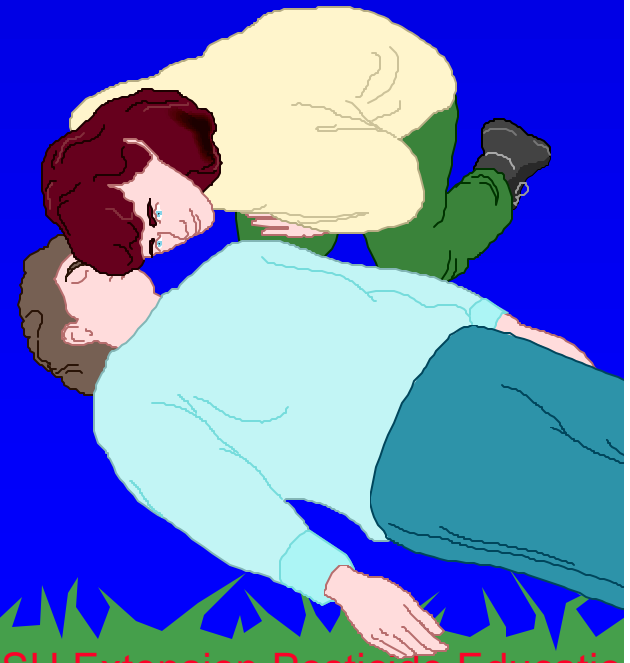

# *Symptoms of Pesticide Poisoning*

## ■ Fungicides- general:

- headache
- skin irritation
- sweating
- muscle twitching or fatigue
- coughing, hoarseness, chest pains
- burning sinuses, throat, lungs



# *Symptoms of Pesticide Poisoning*

## ■ Phenoxy herbicides:

- skin or eye irritation
- mouth/throat irritation
- abdominal pain, vomiting
- diarrhea
- chest pain
- muscle twitching or weakness

# *Symptoms of Pesticide Poisoning*

## ■ Arsenical herbicides

- mild skin irritation
- ingestion may result in burning of the throat, stomach irritation, vomiting and bloody diarrhea

# *Symptoms of Pesticide Poisoning*

## ■ Insecticides- general:

- headache
- blurred vision
- abnormal eye pupils
- greatly increased sweating, salivation, tearing, or respiratory secretions.



# *Symptoms of Pesticide Poisoning*

## ■ Insecticides- cholinesterase inhibiting:

### – Mild poisoning:

- ◆ fatigue, headache
- ◆ dizziness, blurred vision
- ◆ excessive sweating, salivation
- ◆ nausea, vomiting
- ◆ stomach cramps, diarrhea

# *Symptoms of Pesticide Poisoning*

- **Insecticides- cholinesterase inhibiting:**
  - **Moderate poisoning:**
    - ◆ **unable to walk**
    - ◆ **weakness**
    - ◆ **chest discomfort**
    - ◆ **pinpoint pupils**
    - ◆ **earlier symptoms become more severe**

# *Symptoms of Pesticide Poisoning*

## ■ Insecticides- cholinesterase inhibiting:

### – Severe poisoning:

- ◆ unconsciousness
- ◆ severe pin point pupils
- ◆ muscle twitching
- ◆ secretions from mouth and nose
- ◆ breathing difficulty
- ◆ coma, **death**

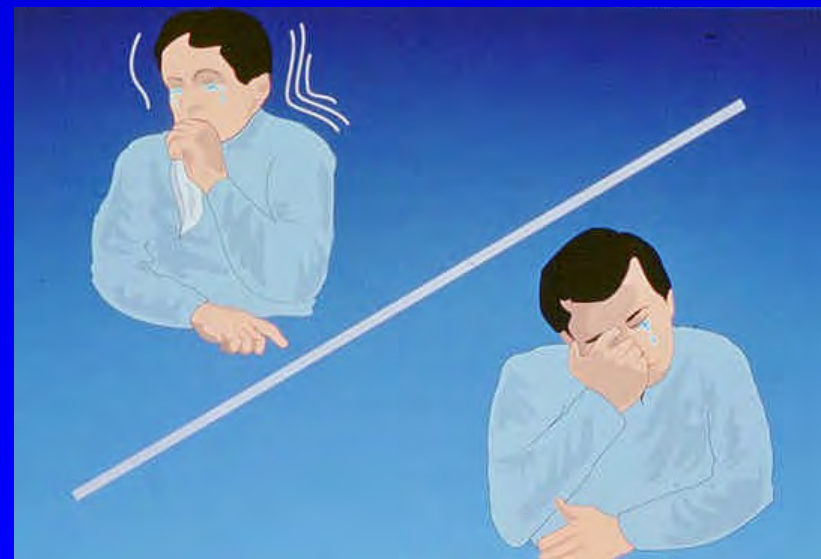

**Small doses of organophosphates  
“add up” in the nervous system.  
Poisoning may result without  
obvious symptoms. Let your doctor  
decide whether pesticide poisoning  
has occurred.**



# Applicator and Doctor



# *First Aid Procedures*

- Varies according to the type of exposure.
- Symptoms may not occur immediately.
- After severe exposure *DO NOT* put off first aid until you feel bad - Act immediately!

# *Dermal Exposure*

- Remove contaminated clothing
- Drench skin with water
- Wash with soap
- Rinse completely
- Wash and rinse again
- Dry, wrap in blanket or clean clothing.



# *Inhalation Exposure*

- Get to fresh air
- Don't attempt rescue in enclosed area without proper respiratory gear
- Keep victim quiet
- Prevent chilling, don't overheat
- Loosen tight clothing
- Resuscitate, if necessary
- Keep air passages clear

# *Eye Exposure*

- Act immediately!
- Wash eyes with a gentle stream of water. Use large amounts of water. Continue washing for 15+ minutes.
- Use pure water only.
- Get medical attention if there is pain or reddening of the eye

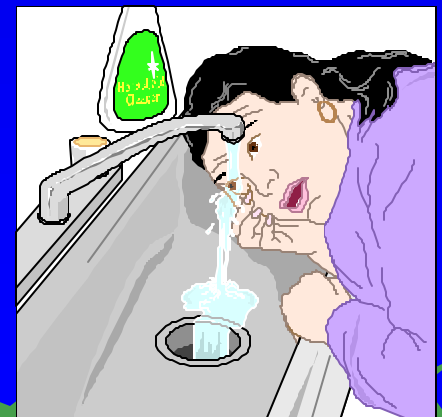

# *Oral Exposure*

- If pesticide has entered mouth, but not swallowed:
  - Rinse thoroughly
- If swallowed:
  - Follow label directions on whether to induce vomiting

## ***Never induce vomiting if....***

- 1. Victim unconscious**
- 2. Having convulsions**
- 3. Petroleum based product**
- 4. Corrosive pesticide**
- 5. Label specifies not to induce vomiting**

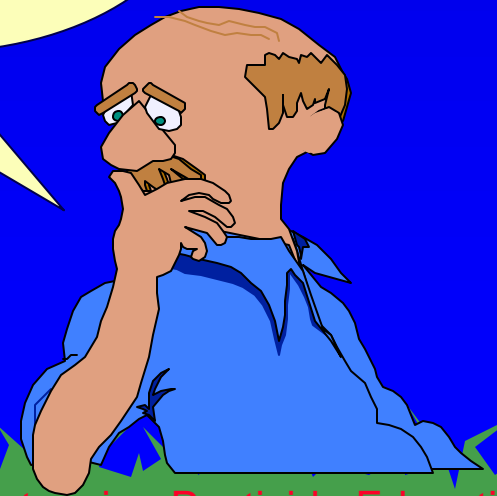

**Don't waste time, get to the hospital ASAP!**

**Do not attempt to administer antidotes!**



# *Safe Pesticide Handling*

***Preventing accidents when handling pesticides is the best way to protect:***

- the applicator**
- the environment**
- nontarget organisms**

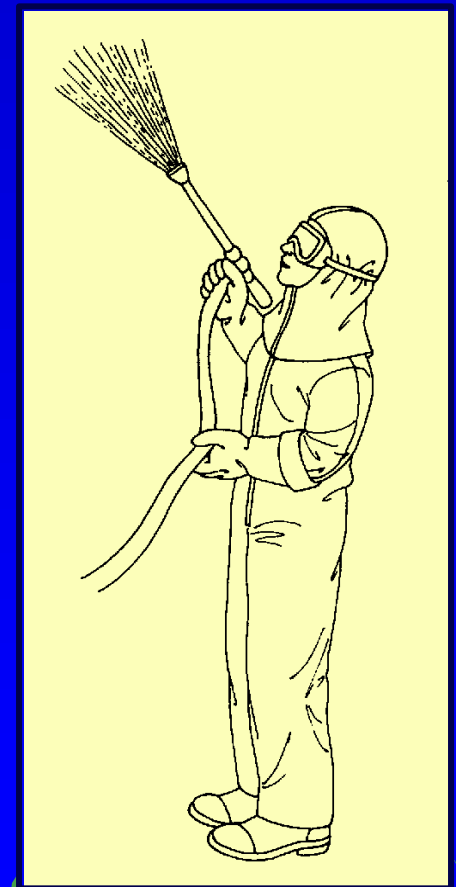
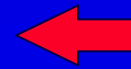



# *Equipment Safety*

## ■ Check for:

- Worn hoses
- Leaks
- Applicator accuracy
- Truck and trailer safety
  - Brakes
  - Lights
  - Tires

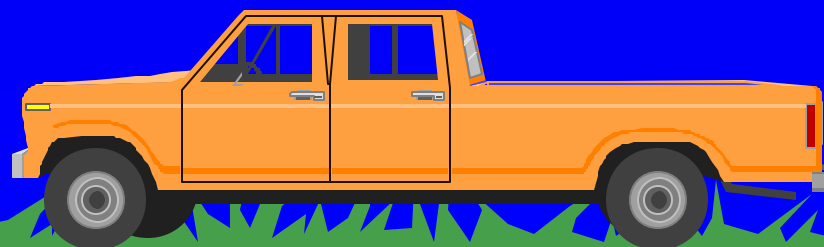

# *Mixing and Loading Pesticides*

- **Mixing and loading pesticide concentrates are some of the most hazardous activities for the applicator and environment.**

# *Mixing Safely*

- Wear protective clothing.
- Do not eat, smoke, chew gum.
- Lighted, well ventilated area, shelter from wind.
- Attend tank while filling.
- Follow label directions.

# Backflow prevention device.

# *Mixing Pesticides Safely*

- Keep fill hose *out* of solution.
- Anti-siphon valve.
- Pour below eye level.
- Measure accurately.
- Rinse measuring tools.
- Triple rinse containers immediately.



# *Triple Rinse & Pesticide Removal*



# Pesticide Fate?

# *Pesticides: Undesirable Effects*

- **Suppression of thatch decomposers**
- **Destruction of predator & parasites**
- **Risk to applicator**
- **Exposure to people and pets**



# *Pesticides: Undesirable Effects*

- Effect on wildlife
- Runoff to streams, ponds
- Groundwater contamination

**Since most turf stands are in areas frequented by people, it is especially important for 3A applicators to be safety conscious. People depend on you to protect them from pesticide residues.**

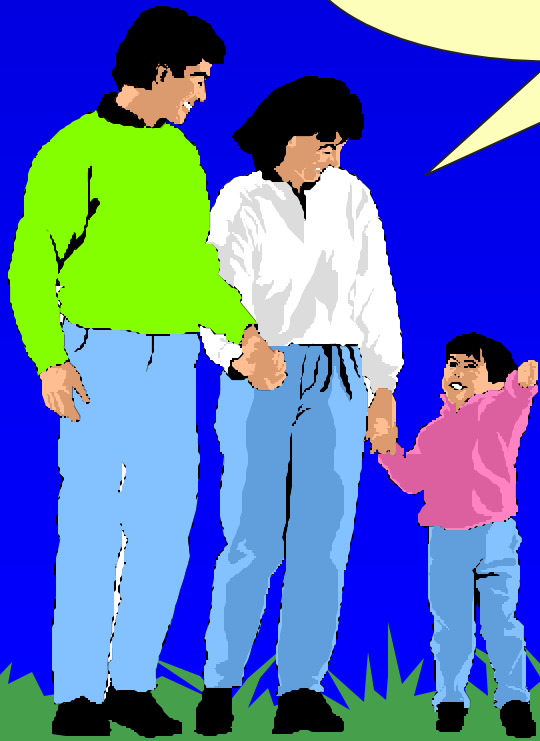

# *Applying Pesticides Safely*

- Check over the fence.
- Clients should:
  - move cars, close windows
- Remove, cover or wash
  - pet dishes, toys, bird feeders, etc.
- Be aware of food plants
- Explain reentry intervals

**Pesticide application  
equipment is attractive to  
children. Never leave  
equipment unattended!**

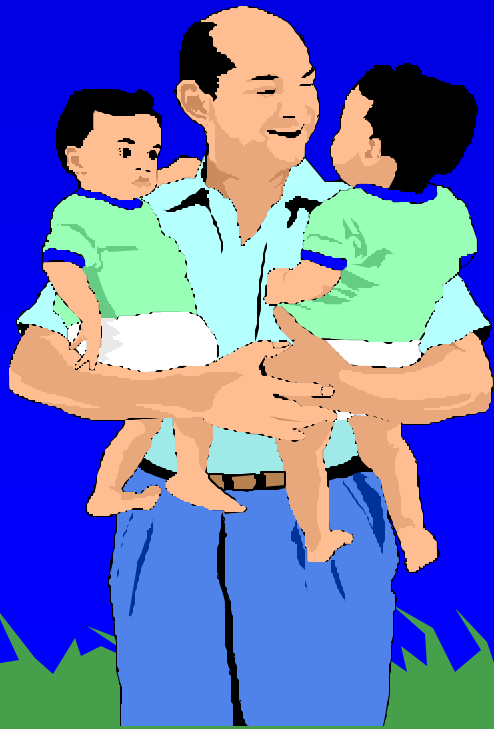

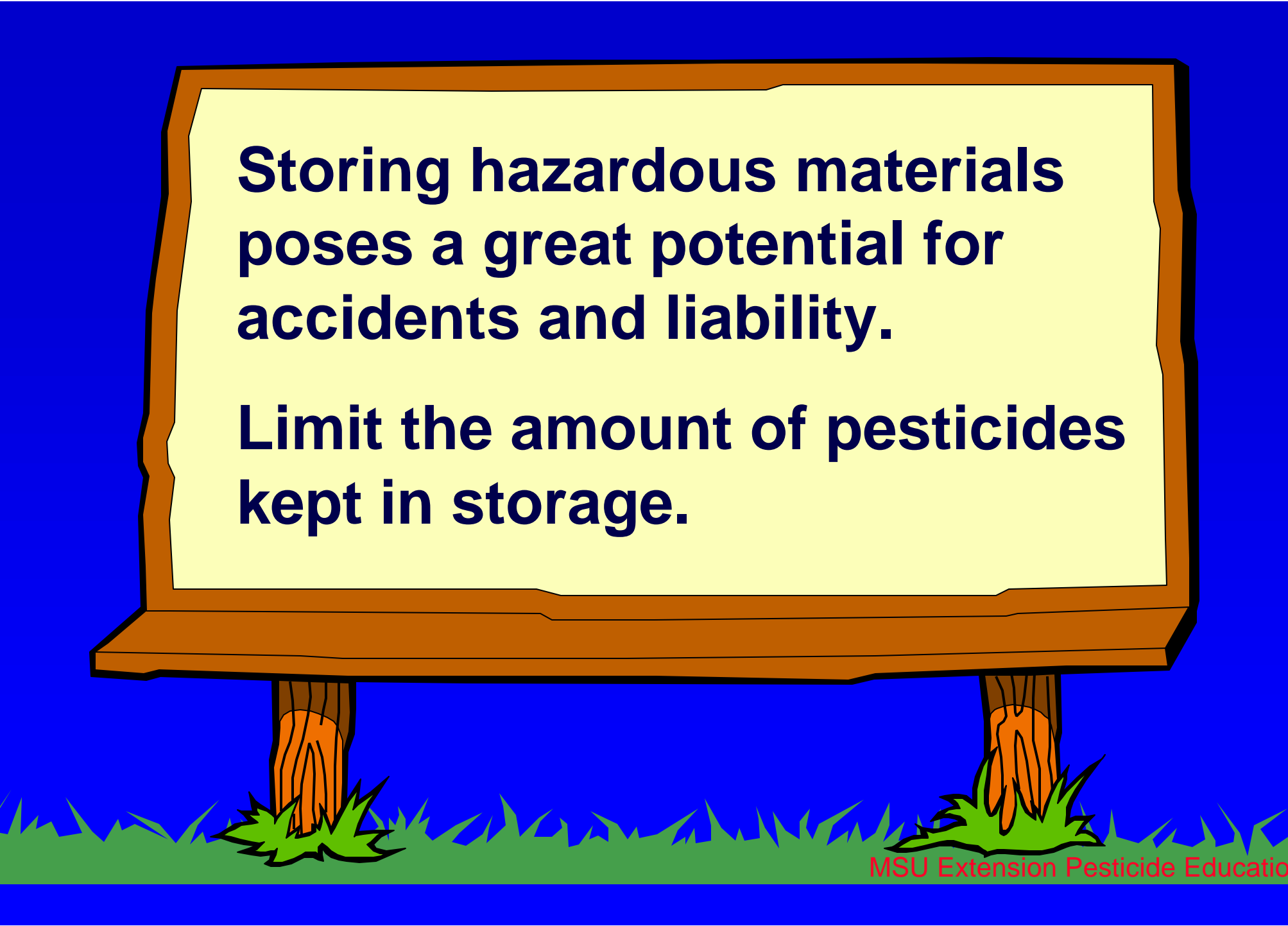

**Storing hazardous materials  
poses a great potential for  
accidents and liability.**

**Limit the amount of pesticides  
kept in storage.**

**Chemical fires can be toxic. You may need to report storage of certain chemicals. Check with MDNR (MDEQ) or MSUE about SARA Title III requirements.**



# *Exterior Pesticide Storage*

- Not near well
- Secured
- Ventilated
- Posted
- Fire-proof
- Secondary containment
- Separate storage for volatile herbicides

# *Interior Pesticide Storage*

- Inventory sheet
- Moderate temperatures
- NO SMOKING
- Fire extinguisher
- Spill kit
- Metal Shelving
- Protective clothing
- Emergency telephone numbers



**Storage regulations may change.  
Contact MDA or MSUE for updates.**

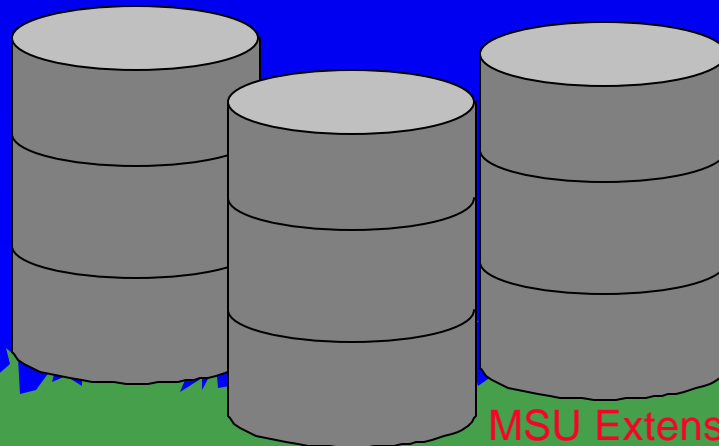
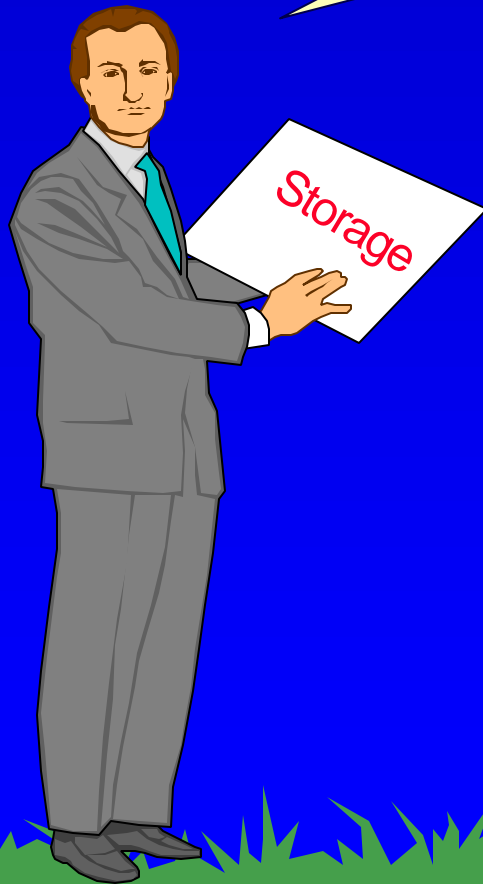

# *Pesticide Containers*

- Keep in original container
- Protect labels
- Label all containers
- Do *NOT* use  
food containers!

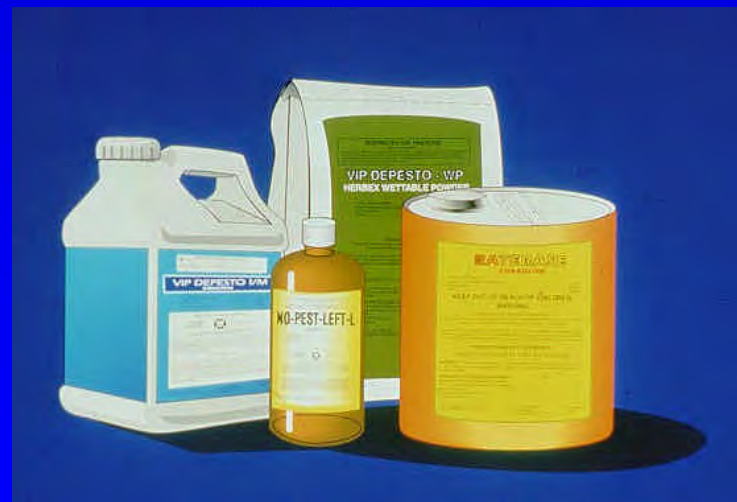

# *Pesticide Containers*

- Reseal open packages
- Use old or damaged first
- Mark mixing containers
- Triple rinse and puncture
- Buy refillables or recycle



A cartoon illustration of a person with brown hair, wearing a yellow hard hat, a blue short-sleeved shirt, and brown pants. The person is shown from the side, pointing their right hand towards a large yellow sign. The background is a solid blue color with a green grassy area at the bottom.

**Pesticide wastes can be a problem.**

- don't stock up
- mix only what is needed
- apply leftovers according to the label
- use material in open containers

**Pesticide waste disposal is regulated. Contact the MDNR (MDEQ), MSUE or MDA for assistance.**



# *Pesticide Spills*

- **Control** and stop the spill
- **Contain** the spill
- **Clean up** the spill
- **Report** the spill
  - Contact MDA, MSUE, MDEQ for procedures.

# *Regulation 637*

- Contracts
- IPM
- Protective gear
- Notification registry
- Posting
- Drift management
- Use standards
- Mixing and loading
- Washing equipment

# *Professional Applicator*

- Communicate
- Keep up to date
- Train employees
- Look and act professionally





**Sell your skills and  
knowledge... consult!**

**Educate your customers!**



# *Educate Customers*

- Not all organisms are pests
- Natural control allows some pests
- Aesthetic or health threatening
- Timing for pest management



# *Educate Customers*

- **Inspect turf regularly**
- **Targeted control tactics**
- **Pesticides may or may not be the best method of pest management**

# *Professional Applicator*



# *Turfgrass Pest Management (Category 3A)*

## **Weeds of Turfgrass**

### **Chapter 7**



# Weed

**Any plant growing  
where it is not  
wanted!**





**Tall fescue in bluegrass stand.**

# *Weeds*

## ■ Compete with turf for:

- Growing space
- Water
- Nutrients
- Sunlight





# *Weed and Site Conditions*

- Weeds can thrive in poor conditions
  - Shade: ground ivy, common chickweed
  - Compacted soil: knotweed, annual bluegrass



Ground ivy



Knotweed

# *Weeds and Site Conditions*

- Wet areas: nutsedge, white clover, annual bluegrass
- Heavy wear: yarrow, spurge, knotweed



Weeds are the result of  
poor turfgrass  
performance, not the  
cause!



**The success of weed management depends on choosing tactics based on the biology of the specific weed.**

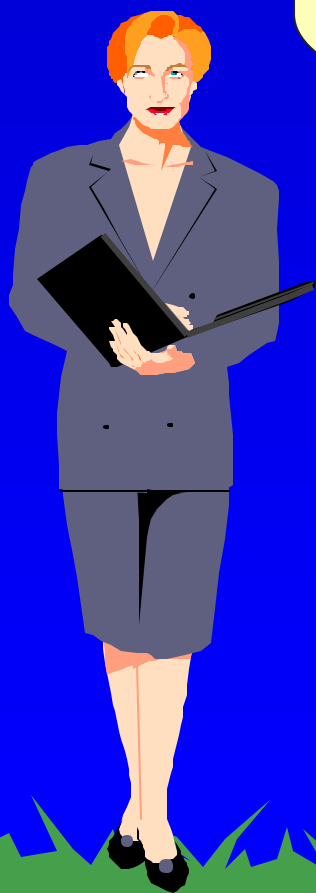

Monocot

Dicot

# ***Weed Biology***

## ■ **Monocot-narrow leaf:**

- Parallel leaf veins
- Growing points at or below soil level
- Only herbaceous monocots found in MI

## ■ **Dicot-broadleaf:**

- Veins radiate out from main vein
- Above and below ground growing points
- Woody and herbaceous

# *Monocot*

## ■ Grasses

- Annual (crabgrass)
- Perennial (tall fescue)

## ■ Sedge

- Nutsedge

## ■ Lily

- Wild garlic



# *Dicot*

## ■ Many families of dicot weed species:

- Composite (dandelion)
- Mustard (shepherdspurse)
- Carrot (wild carrot)
- Morning glory (field bindweed)



# *Plant Development Stages*

## ■ 1. Seedling

- Tender and vulnerable to stresses

## ■ 2. Vegetative

- Great uptake of water and nutrients

## ■ 3. Seed production

- Slow uptake of water and nutrients directed to flower, fruit, seed

## ■ 4. Maturity

- Little uptake of water and nutrients
- Low energy production



The development stage of a weed affects how it responds to your management tactics.

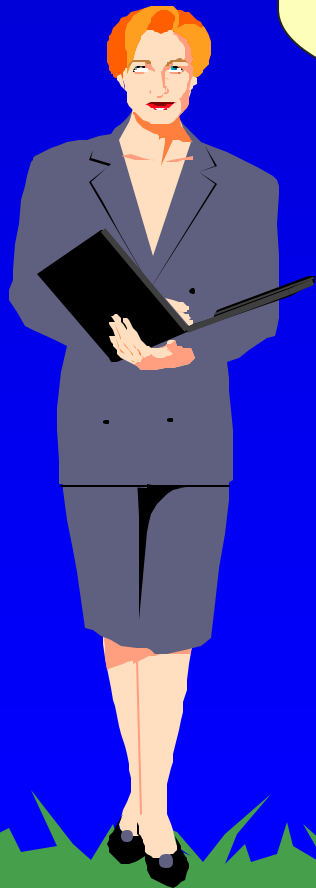

**Seedling:** Susceptible to cultural methods.

**Vegetative:** Rapid herbicide uptake.

# *Weed Life Cycles*

## ■ Annual

— Summer

— Winter

## ■ Biennial

## ■ Perennial

1998						
			1	2	3	4
5	6	7	8	9	10	11
12	13	14	15	16	17	18
19	20	21	22	23	24	25
26	27	28	29	30	31	

# *Weed Seasonality*

## ■ Cool-season plants

- Grow best during cool periods of spring and fall
- Winter annuals; some perennials

## ■ Warm-season plants

- Remain dormant or do not germinate until May or June
- Summer annuals; some perennials



## **Grass or Sedge??**

**Weed identification is key to a successful weed management program. Have references available.**

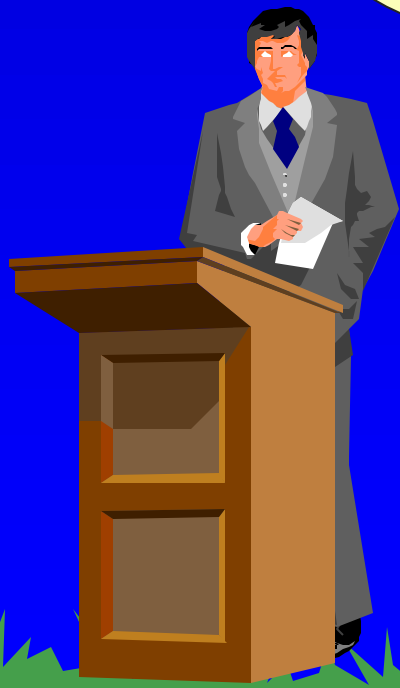





**Keep records of  
weed  
populations and  
effectiveness of  
your  
management  
efforts.**

# *Managing Turf Weeds*

1. **Maintain vigorous turf stands.**
2. **Prevent seed production.**
3. **Prevent seed germination.**

# *Managing Turf Weeds*

4. Eliminate weed seedlings.
5. Target susceptible stages of developed weeds .

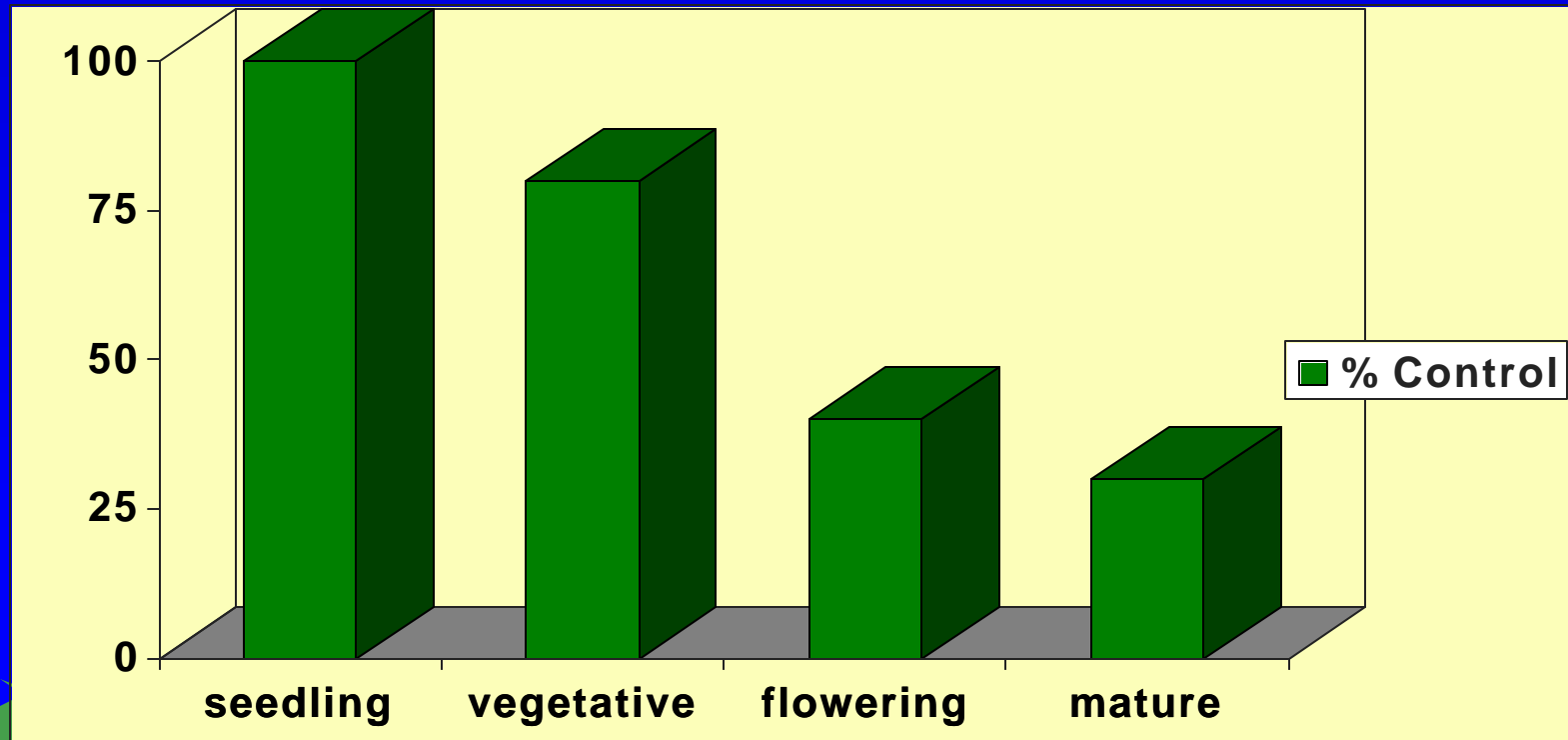



**There are many herbicides marketed for turf weed management. Understand their characteristics and read the label carefully.**



# *Herbicide Characteristics*

- Contact
- Systemic
- Persistent
- Non- persistent
- Selective
- Non- selective
- Pre- emergent
- Post- emergent

# *Herbicide Action and Weed Characteristics*

- Growing points
- Leaf shape
- Wax and cuticle
- Leaf hairs
- Deactivation
- Life cycle stage

# *Herbicide Action and Weather*

- Control depends on conditions during and after application:
  - Rains may leach the herbicide
  - Light rain may be needed to activate the herbicide
  - Sunlight and heat may increase volatility
  - Wind increases drift
- Read and follow the label!



# *Read the Label*



***Turfgrass Pest  
Management (Category 3A)***

**Diseases of Turfgrass**

**Chapter 8**

**Diseases can be difficult  
plant disorders to  
diagnose and manage.**



**Disease = disturbance of normal  
plant function.**

# *Diseases*

## ■ Non-infectious:

- Not spread between plants
- Cultural, environmental



## ■ Infectious:

- Spread between plants
- Caused by pathogens





# *Pathogens*

- **Fungi:**

- Most common cause of infectious turfgrass diseases

- **Bacteria**

- **Virus**

- **Nematodes**

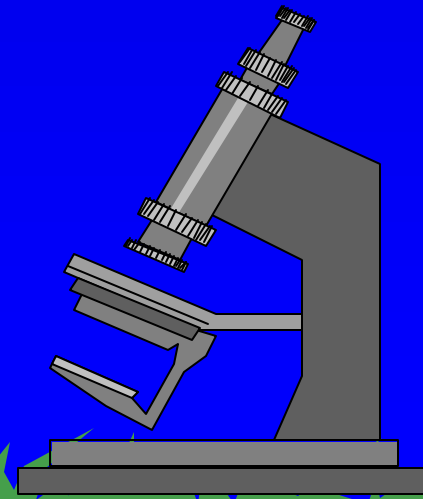

# *Fungi*

- Most fungi feed on decaying organic matter.
- Only a few species attack living plants.
- Fungi reproduce by spores.

# *Fungi*

- Most prefer or require moisture for growth, infection, spore germination.
- Resting stage found in leaves, stems, roots.
- Overwinter in thatch and near soil surface.

# *Nematodes*

- 1/50 to 1/10 inch, slender round worms.
- Spread by eggs and anything that can contain eggs or adults.
- Only a few species feed on turfgrasses.



Infected root.

# *Nematode Information*

- Needle-like mouthpart (stylet) punctures plant tissue.
- Infested turf:
  - Lacks vigor.
  - Does not respond well to cultural practices.
  - More susceptible to cultural and pest damage.

**To identify nematode damage, send plants and soil to a lab, such as the MSU Plant and Pest Diagnostic Clinic.**



Not all turfgrasses exposed to a disease become infected. The **“Plant Disease Triangle”** must be completed.



Plant Disease Triangle

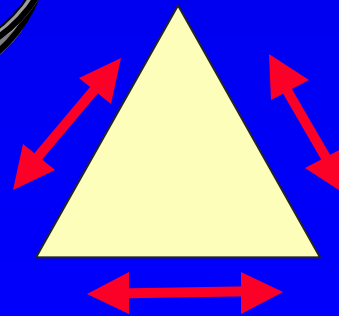

**Susceptible Host**

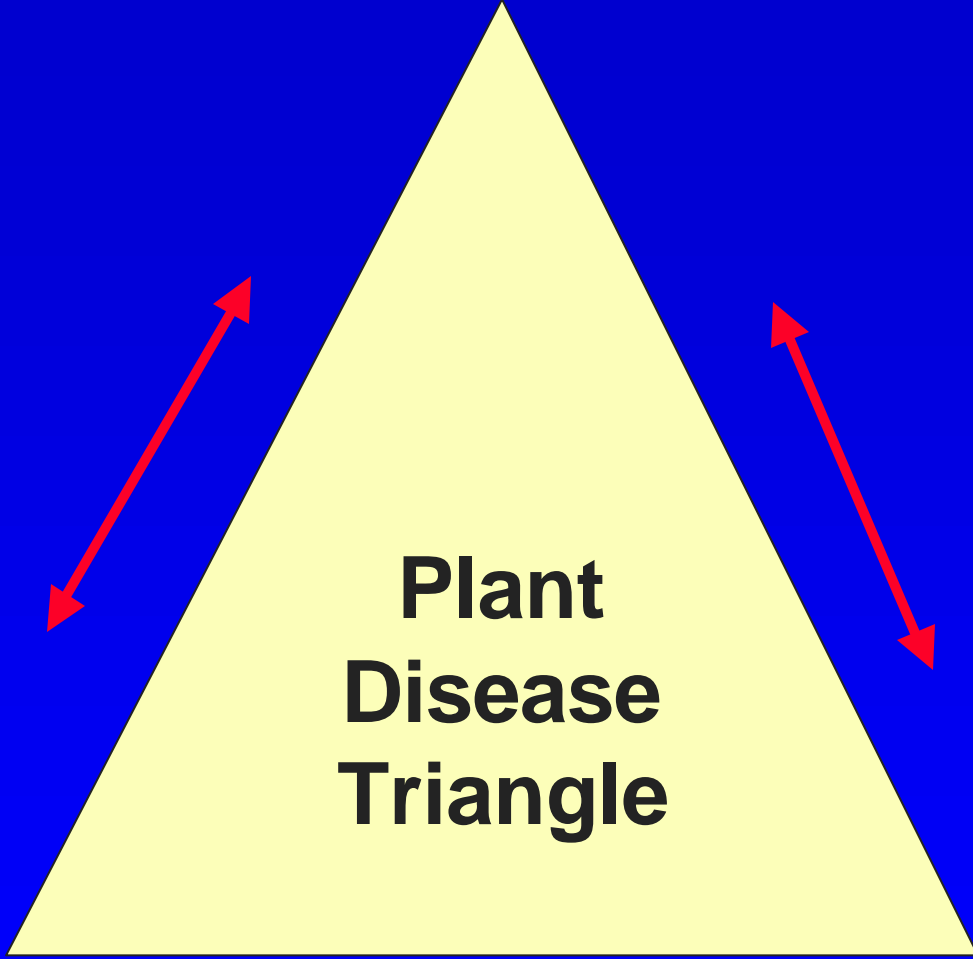

**Plant  
Disease  
Triangle**

**Casual  
Agent**

**Favorable  
Environment**





**Disease management requires determining if the injury is caused by an infectious disease. If so, identify which pathogen.**

# *Turfgrass Disease Diagnosis*



- Pathogen microscopic
  - Diagnosis difficult
- Symptoms are often used
- Pathogens vary significantly:
  - Host
  - Environmental conditions, weather
  - Species and variety of grass

**You may need to use the services of the MSU Plant and Pest Diagnostic Lab to identify the causal agent or pathogen on your sample. Check with county Extension office for assistance.**



# *Common Turfgrass Diseases*

- Anthracnose
- Dollar spot
- Fairy rings
- Fusarium patch
- Leafspot and Melting out
- Necrotic ring spot
- Nematodes
- Powdery mildew
- Pythium
- Red thread
- Rhizoctonia brown patch
- Rust
- Slime mold
- Stripe smut
- Pink snow mold

# *Anthracnose*

## ■ Description:

- Host: annual bluegrass
- Patches of turf 2 in. to 10 ft. turn yellow-bronze to reddish brown.
- Develops most rapidly during hot, humid weather or other stresses.
- “Spiny cushions” of spores may be visible on blades (need hand lens to see spines).



# *Anthracnose*

- **Management:**
  - **Maintain adequate fertility**
  - **Reduce all types of stress**
  - **Fungicides**



# *Dollar Spot*

## ■ Description:

- Bentgrass, bluegrass, perennial ryegrass.
- Bleached areas of turf = size of silver dollar.
- Spots may merge - blight large areas.
- Tan lesions with a dark border girdle blades.
- White mycelium may be visible in morning.

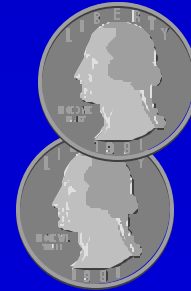

# *Dollar Spot*

## ■ Management:

- Maintain adequate nitrogen levels
- Fungicides



Bulk Fertilizer Application



# *Fairy Rings*

## ■ Description:

- Dark green ring, mushrooms
- Caused by fungi that breakdown organic matter
- Often appear after rains or heavy irrigation
- Size varies
- More serious problem on golf greens

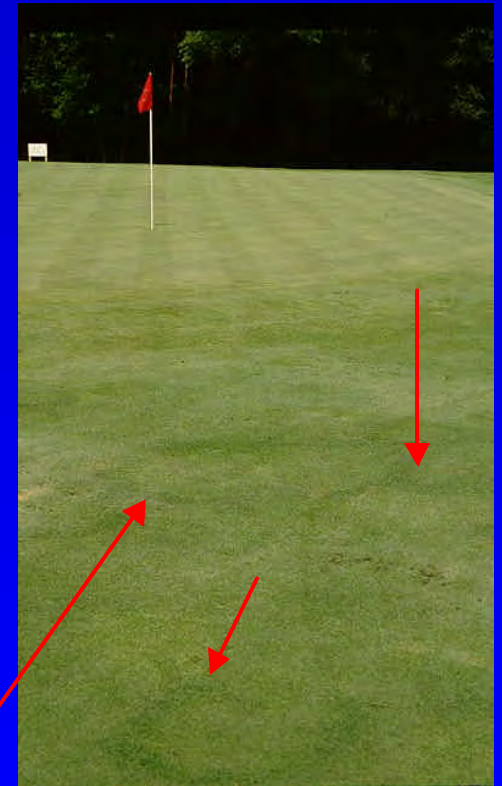

# *Fairy Rings*

## ■ Management:

- Mask symptoms with fertilization.
  - ♦ May stimulate some fairy ring fungi
- Difficult and expensive to control.
- Replace infested soil.
- Fumigation of the soil.



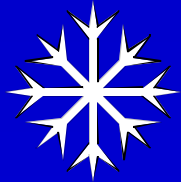

# *Fusarium Patch*

*(Pink Snow Mold, Microdochium Patch)*

## ■ Description:

- Fungus survives in thatch and residue
- Develops in cool (45 F) and wet conditions
- Whitish-grey or reddish brown spots from 2 in. to 2 ft in diameter
- Develops with or without snow cover
- Annual bluegrass, perennial ryegrass, bentgrass are susceptible



# *Fusarium Patch*

*(Pink Snow Mold, Microdochium Patch)*

## ■ Management:

- Allow grass to harden off before winter
  - ◆ Manage late season fertility
- Fungicides



# *Leafspot and Melting Out Diseases*

## ■ Description:

- Several species of fungi
- Most active during cool, moist weather
- Fungi may spread to the crowns during stress causing “melting out”
- Damage may be confused with other pests
- Leafspot: creeping bentgrass, fine fescues
- Melting out: Kentucky bluegrasses

# *Leafspot and Melting Out Diseases*

## ■ Management:

- Resistant turf varieties
- Limit stress
- Avoid lush, wet turf
- Fungicides
  - ◆ Time consuming
  - ◆ Expensive

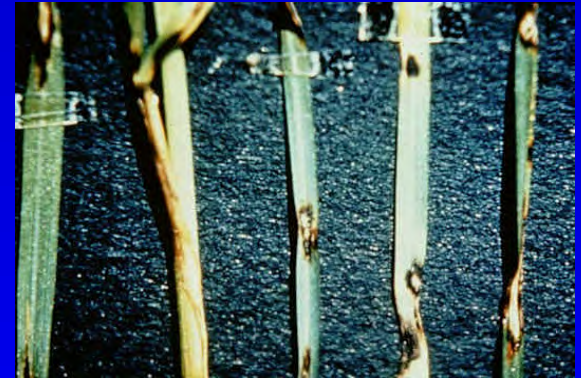

# *Necrotic Ring Spot*

## ■ Description:

- Wilted, dying or dead turf in spots 2 to 12 inches wide
- Patches may grow together causing steaks, crescents, or circles
- “Frogeye” pattern typical
- Symptoms become obvious during drought stress



# *Necrotic Ring Spot*

## ■ Management:

- Use resistant varieties
- Avoid stressing turf in any way
  - ◆ Fertility
  - ◆ Irrigation
  - ◆ Thatch management
- Fungicides





# *Nematodes*

## ■ Description:

- Turf lacks vigor
  - ◆ Thin, stunted, off color, slow growing
- Fails to respond to water & fertilizer
- Plants wilt during mid-day
- Die in irregular patches
- Roots abnormal

# *Nematodes*

## ■ Management:

- Laboratory diagnosis
- Reduce stress
  - ◆ Frequent, light mid-day irrigation
- Nematicides

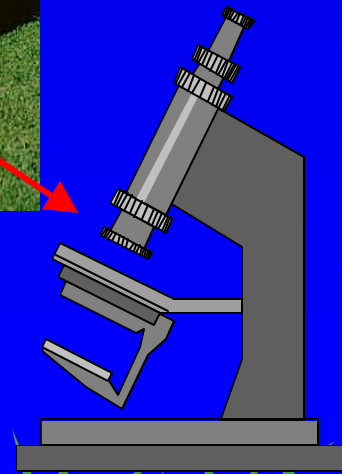

# *Powdery Mildew*

## ■ Description:

- White, powdery coating on the leaves
- Common during spring and fall
- Enhanced by shade, wetness, etc.
- Plant growth reduced
- Infected plants may wither and die

# *Powdery Mildew*

## ■ Management:

- Avoid planting shady, wet areas with Kentucky bluegrass
  - ◆ Use shade tolerant grasses
- Trim trees and shrubs
  - ◆ Increase sunlight
  - ◆ Increase air circulation



# *Pythium Blight*

## ■ Description:

- Round to irregular water-soaked , “greasy” sunken patches, up to 12 in. wide.
- Hot weather, usually confined to wet areas.
- Early morning- fluffy white mold growth may be visible.
- Damage may appear in streaks following drainage or mowing patterns.



# *Pythium Blight*

## ■ Management:

- Improve drainage.
- Avoid creating excessively lush turfgrass.
  - ◆ Adjustment cultural practices as necessary
- Fungicides - Know the weather forecast.



# *Red Thread*

## ■ Description:

- Irregular to circular, “ragged” light tan to pink patches, 2 to 12 inches in diameter.
- Develops during prolonged humid weather.
- Reddish- pinkish fungal threads protrude from the leaves.
- Infected patches may merge.



# *Red Thread*

## ■ Management:

- Maintain turf vigor.
- Remove clippings to reduce inoculum.





# *Rhizoctonia Brown Patch*

## ■ Description:

- Brown patches, up to 2 ft.
- Appear during hot, moist, overcast weather.
- Grayish-black “smoke” ring of wilted turf may develop on the edge of the patch.



# *Rhizoctonia Brown Patch*

## ■ Management:

- Avoid excessive nitrogen.
- Remove dew.
- Increase air circulation.
- Fungicides.



# *Rust*

## ■ Description:

- Primarily ryegrass and bluegrass.
- Turf becomes reddish brown from fungi pustules.
- Spores rub off on shoes.
- Weakened turf susceptible to other diseases and stresses.
- Develops when growth is reduced.



# *Rust*

## ■ Management:

- Use resistant turfgrass varieties.
- Maintain vigorously growing turfgrasses.

Resistant varieties  
and good cultural  
practices.



# *Slime Mold*

## ■ Description:

- Harmless fungi that feed on decaying organic matter.
- During warm weather, white, gray, black, or cream slimy masses grow over leaves.
- Develops in patches or streaks.
- Masses dry to ash- gray crusty mats.



# *Slime Mold*

## ■ Management:

- Slime molds soon disappear.
- Rarely occur more than once a season.
- Rake, brush, or spray with water to remove the mold.
- Chemical control NOT recommended.

# *Stripe Smut*

## ■ Description:

- Cool weather disease of bluegrass and bentgrass.
- Symptoms are subtle and difficult to detect until damage is extensive.
- Turf stunted.
- Infected blades have long black pustules that open liberating black spores.
- Infected leaves twisted and shredded.



# *Stripe Smut*

## ■ Management:

- Resistant grasses.
- Established infection is difficult to control.
- Fungicides suppress smut for only a short period.
- Maintain good cultural practices.
- Do not allow turf to go dormant in summer.



# *Typhula Blight* (*Gray Snow Mold*)

## ■ Description:

- As snow melts, circular gray or brown spots appear in the turf.
- Grayish- white fungal strands are visible.
- More severe when snow falls on unfrozen lush turf .



# *Typhula Blight* *(Gray Snow Mold)*

## ■ Management:

- Avoid creating lush, tender fall growth.
- Resistant turfgrasses.
- Fungicides.

# *Predicting Disease Activity*

- Host susceptibility
- Weather conditions
- Microclimate



Weather station

**Disease management efforts focus on preventing diseases from occurring or lessening the damage.**



# *Infectious Disease Management*

- Resistance
- Avoidance
- Protection

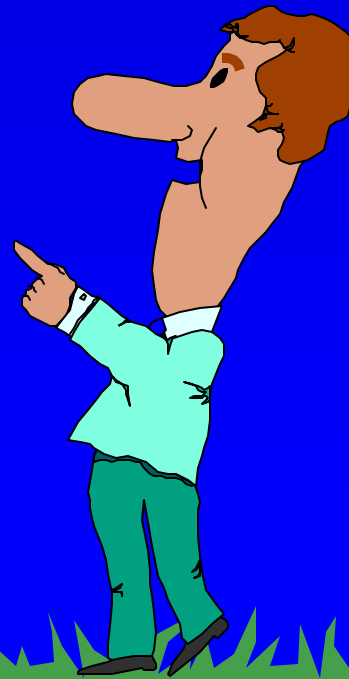

***Turfgrass Pest  
Management (Category 3A)***

**Insect and Vertebrate  
Pests**

**Chapter 9**

Two groups of animals  
commonly injure turfgrass.

**Insects:** eat roots, stems, leaves,  
sap.

**Vertebrates:** tear up grasses and  
damage roots.



**The first step in managing turfgrass insects is accurate identification. Most insects are not pests!**

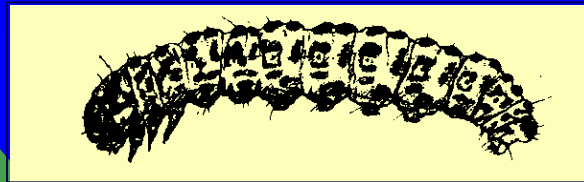



**Turf insects are grouped by those that:**

- Feed on the roots**
- Feed on grass blades and stems**
- Are nuisance pests.**



# *Root Feeding Insects*

## ■ Grubs:

- Japanese beetle
- European chafer
- June beetle
- Black turfgrass ataenius
- *Aphodius granarius*



Other white grubs

# *Japanese Beetle-Larvae*

## ■ Damage:

- Feed on roots in May and early June and again in Sept. and October
- Moisture stress causes damaged turf to turn brown .

## ■ Appearance:

- White C-shaped grubs to 1.”

## ■ Threshold:

- 20-30/sq. ft. on irrigated turf.



# *Japanese Beetle-Adult*

- Adults emerge in July - early August.
- Dark metallic green beetle, half inch long.
- Adults feed on wide range of ornamentals.
- Eggs deposited in turf July - August.



# *Japanese Beetle*

- Larvae mature to 1/2 to 1 in. late Sept.
- Damaged turf may die from root pruning.
- Grubs move deeper into soil to overwinter.
- Larvae pupate to beetles following June.

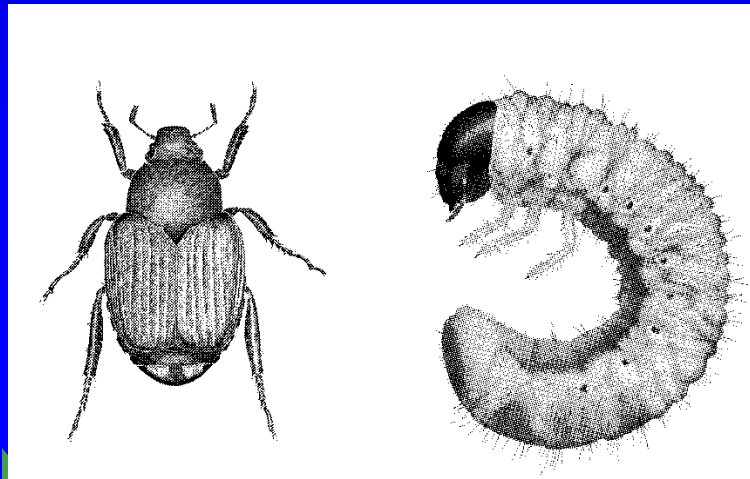

# *Japanese Beetle*

- Skunks and raccoons may rip up turf looking for larvae.
- Irrigated turf has a tremendous ability to recover.
- Monitor populations.
- Insecticides should be watered-in to reach the larvae.

# *Japanese Beetle*

- **Control is highly variable.**
  - 50 to 80% control
  - Check 3 weeks after treatment
- **Beetle traps do not provide control.**
- **Biological insecticides.**
  - Variable results
  - Check for latest efficacy information and new products

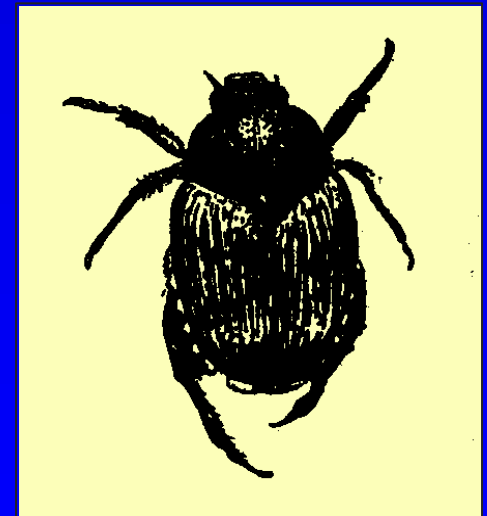

# *European Chafer-Larvae*

## ■ Damage:

- Feed on roots in early May - June and again in Sept. - Oct. Damaged turf may turn brown.

## ■ Appearance:

- White C-shaped grub up to 1.”

## ■ Threshold:

- 20-30/sq. ft. on irrigated turf.





# *European Chafer-Adult*

- Light brown, stout body, clubbed antennae, half in. long.
- Adults emerge in late June and July - about 2 weeks earlier than Japanese beetle.
- Similar one year life cycle.



# *European Chafer Information*

- Grubs feed longer in the fall (early Nov.) and return to the surface sooner (early April) than JB.
- Damage threshold and control similar to Japanese beetle.



# *June Beetle*

## ■ Damage:

- Larvae from May until October
- Vertebrates uproot turf looking for grubs

## ■ Appearance:

- Large C-shaped white grubs, up to 2 in.

## ■ Threshold:

- 10/sq. ft. on irrigated turf, 5 on non-irrigated



# *June Beetle*

- Several species of May or June beetles.
- Adults attracted to lights.
- 3-year life cycle.
- Large larvae difficult to control.



# *June Beetle Information*

- 3rd year grubs not effected by late summer insecticide applications.
- Natural enemies often control this pest.
- Skunks may turn over sod to feed on grubs (all species).



# *Black Turfgrass Ataenius*

## ■ Damage:

- Larvae feed on roots in July - Aug.
- Damage uncommon on home lawns

## ■ Appearance:

- Small, .25 in., black beetles
- White grub up to 3/8 in.

## ■ Threshold:

- 60 to over 100/ sq. ft. of turf

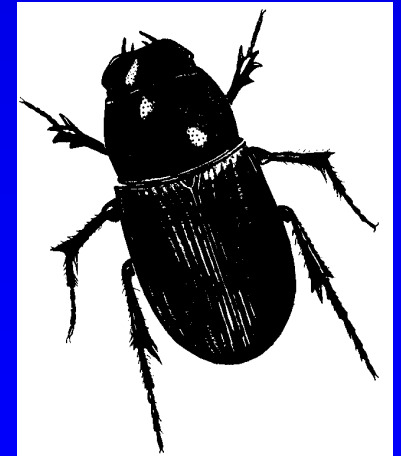

# *Ataenius Information*

- Overwintering adults become active in May-June and lay eggs.
- Turf damage not evident until mid to late July when grubs are mature.



# *Ataenius Information*

- Variable adult emergence.
- Damage rarely occurs when less than 100 grubs/sq. ft are found.
- Control:
  - Sample in July.
  - Treat if more than 80 grubs/sq. ft. are found.





# *Hairy Chinch Bug*



## ■ Damage:

- Large populations can cause damage that looks similar to drought injury

## ■ Appearance:

- Adults are black, 3/16 in. long, white wing markings

## ■ Threshold:

- 20 bugs in 2 minutes of monitoring or 15 per flooded coffee can

# *Chinch Bug*

- 2 generations per year, except north of Lansing.
- Adults overwinter in protected areas.
- Chinch bug larvae and adults suck plant sap.
- Saliva contains a toxic substance to plants.

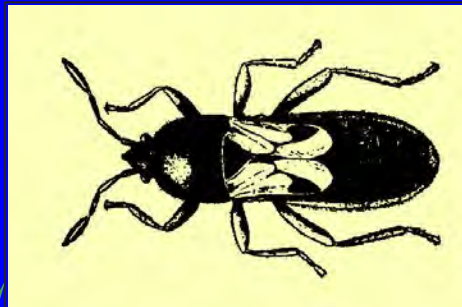

# *Chinch Bug Information*

- Damage can be serious during warm, dry weather.
- Damage develops in mid to late summer.
  - Irregular yellow patches, 2 + ft. in diameter.
  - Some grasses and weeds not damaged.
  - Resembles drought injury.

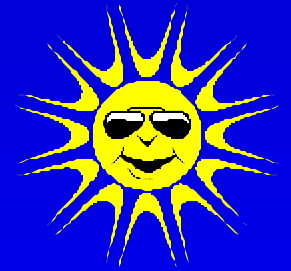

# *Chinch Bug Information*

- During cool, wet weather many bugs are killed by a fungal disease.
- Bugs are wide spread, but rarely abundant enough to cause damage.
- Bugs are seldom a problem in a well irrigated turfgrass area.

# *Bluegrass Billbug*

## ■ Damage:

- Grubs destroy grass crowns causing brown patches of turf in late July.

## ■ Appearance:

- White, legless grubs, 1/4 in. long.

## ■ Threshold:

- If less than 1/3 of lawn is damaged, it will recover with proper care.

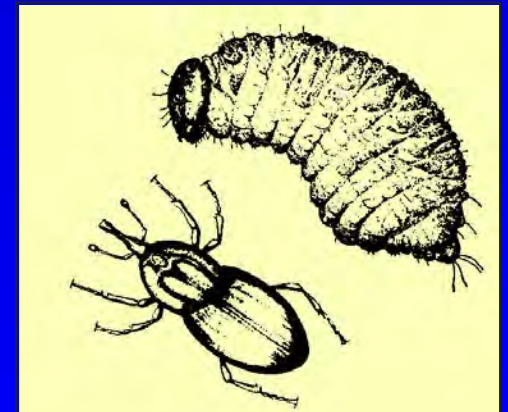

# *Bluegrass Billbug*

- Billbugs overwinter as adults.
- Eggs laid on grass stems in May/early June.
- Larvae tunnel down stem and through crown, often cutting off root system.
- One generation per year.



# *Bluegrass Billbug*

- **Kentucky bluegrass primary host.**
- **Damage evident in late July.**
  - Small circular and irregular dead areas
  - Stems hollow, grass plants pull out easily
  - Sawdust-like frass in root zone
  - Can be confused with disease injury
- **Well maintained lawns seldom damaged.**

# *Black Cutworm*

## ■ Damage:

- 1/4 in. diameter holes in tees and greens with closely clipped grass .

## ■ Appearance:

- Dark brown caterpillars, 1/4 to 2 in. long.

## ■ Threshold:

- Depends on use of turf.





# *Cutworm Information*

- Adults are dull colored moths.
- Larvae most common during July and August.
- Clipped grass, green fecal pellets are characteristic of activity.



# *Cutworm Information*

- Primarily a problem on golf course greens.
- Disclosing solutions can be used to detect cutworms.
- Home lawns and fairways are tolerant of feeding and rarely need treatment.



# *Sod Webworm*

## ■ Damage:

- Small brown patches where blades have been clipped at the base.
- Patches may grow together.

## ■ Appearance:

- Ivory white caterpillars with black spots, up to 1 in. long.

## ■ Threshold:

- Depends on use of turf.

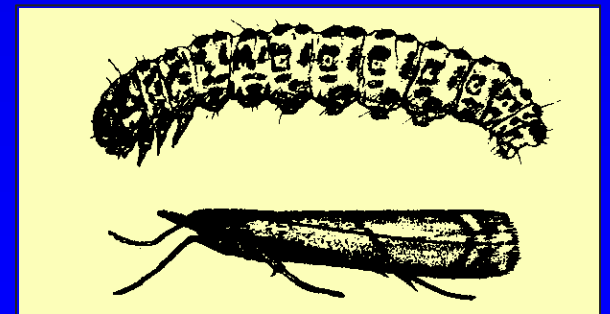

# *Sod Webworm*

- Larvae overwinter and resume feeding in the spring.
- 2 generations per year.
- Dirty white moths may be observed flying across turf at dusk.
- Mowing may “kick up” adults.



# *Sod Webworm*

- Bluegrass and bentgrass favored.
- Most damage from 2nd generation caterpillars.
- Suspect webworms:
  - Brown patches with grass blades missing.
  - Piles of green fecal pellets.
  - Caterpillars living in silk lined tubes.

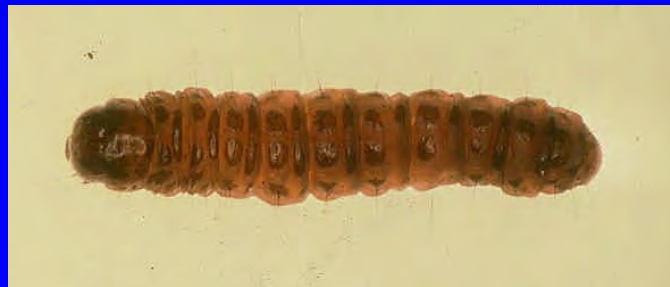

# *Sod Webworm*

- Use a disclosing solution to monitor suspected infestation.
- If more than 4-6 larvae are found per 4 sq. ft., treatment may be advisable.
- Webworms have many natural enemies.
  - Predators and parasites may be suppressed by pesticide use.

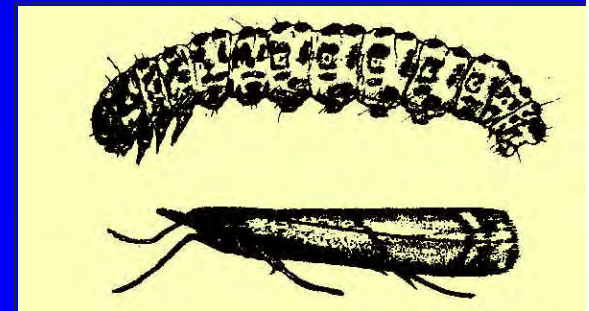

# *Ants*

## ■ Damage:

- Small soil mounds that may be undesirable.

## ■ Appearance:

- Species vary... black, brown, red ants, 1/4 to 1/16 in. long.

## ■ Threshold:

- Depends on tolerance of management, clientele.



# *Ant Information*

- **Ants are beneficial.**
  - Feed on insect eggs and larvae.
- **Ants do not injury turfgrass, but disturb surface uniformity.**
- **More activity in sandy soils.**
- **Primarily a golf green problem.**



# Insect Management

**Vigorous, dense turf can tolerate insect damage by producing new growth.**

**The best approach to insect control is to:**

- Grow healthy turf.**
- Limit pesticide applications.**

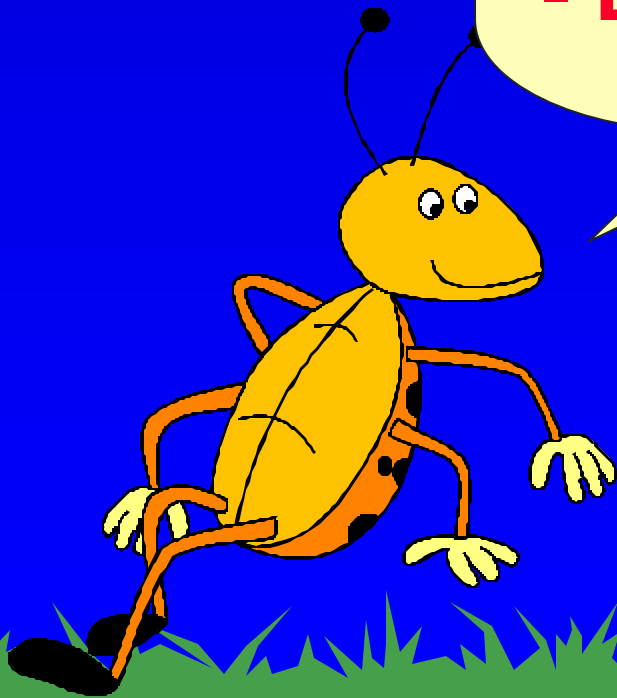



**If damage is unacceptable and non-chemical methods are not effective, an insecticide may be used.**

# *Proper Insecticide Use*

- Base applications on monitoring.



- Protect beneficials.
- Time applications to coincide with susceptible life stages.

# *Proper Insecticide Use*

- **Avoid preventative treatments.**
- **Use low toxicity pesticides when available.**
- **Record and evaluate results of insecticide applications.**

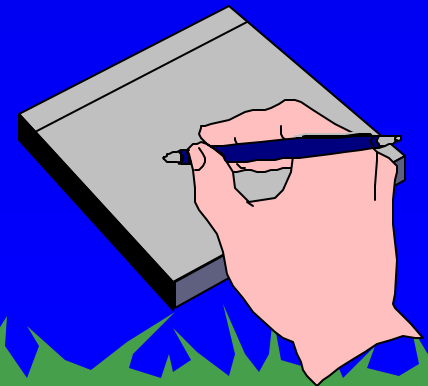

# Vertebrate Pests

Vertebrates have backbones, and are large animals compared to insects. Some vertebrates are beneficial because they consume\* turf pests.

\* Feeding may damage the turf.



# Birds

The blackbird family will puncture the turf with their beaks or rake the turf with their feet to expose prey.



# Skunks, Raccoons Opossums

**Tear up turf to find grubs.**





# Moles

**Tunnel through the soil looking for grubs, earthworms, other insects and animals. Surface can be disrupted by raised ridges and soil piles.**



# *Vertebrate Management*

- Use IPM, etc. to remove the food source.
- Barriers and repellants.
- Trapping
  - Permit required, except for moles, rats, chipmunks.
- Use poison baits with extreme caution.

## Remember:

- **Vertebrates help with pest control.**
- **People like to see wildlife.**
- **Do not injure non-target organisms.**

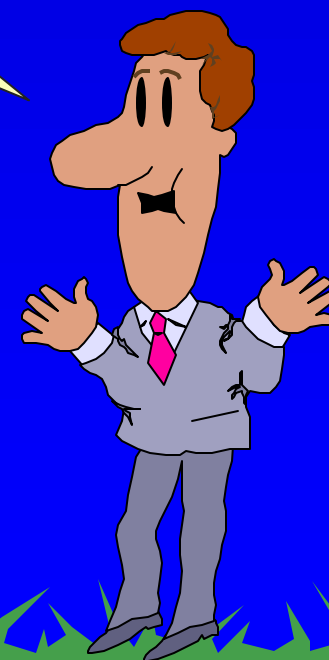
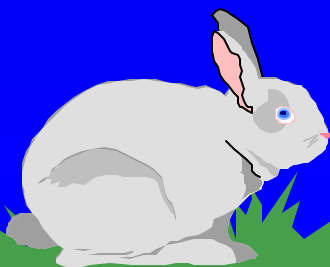

**THE**

**END**

Prepared by: Greg Patchan, Julie Stachecki J., MSUE

